

# QElectroTech

## Éditeur de schémas électriques

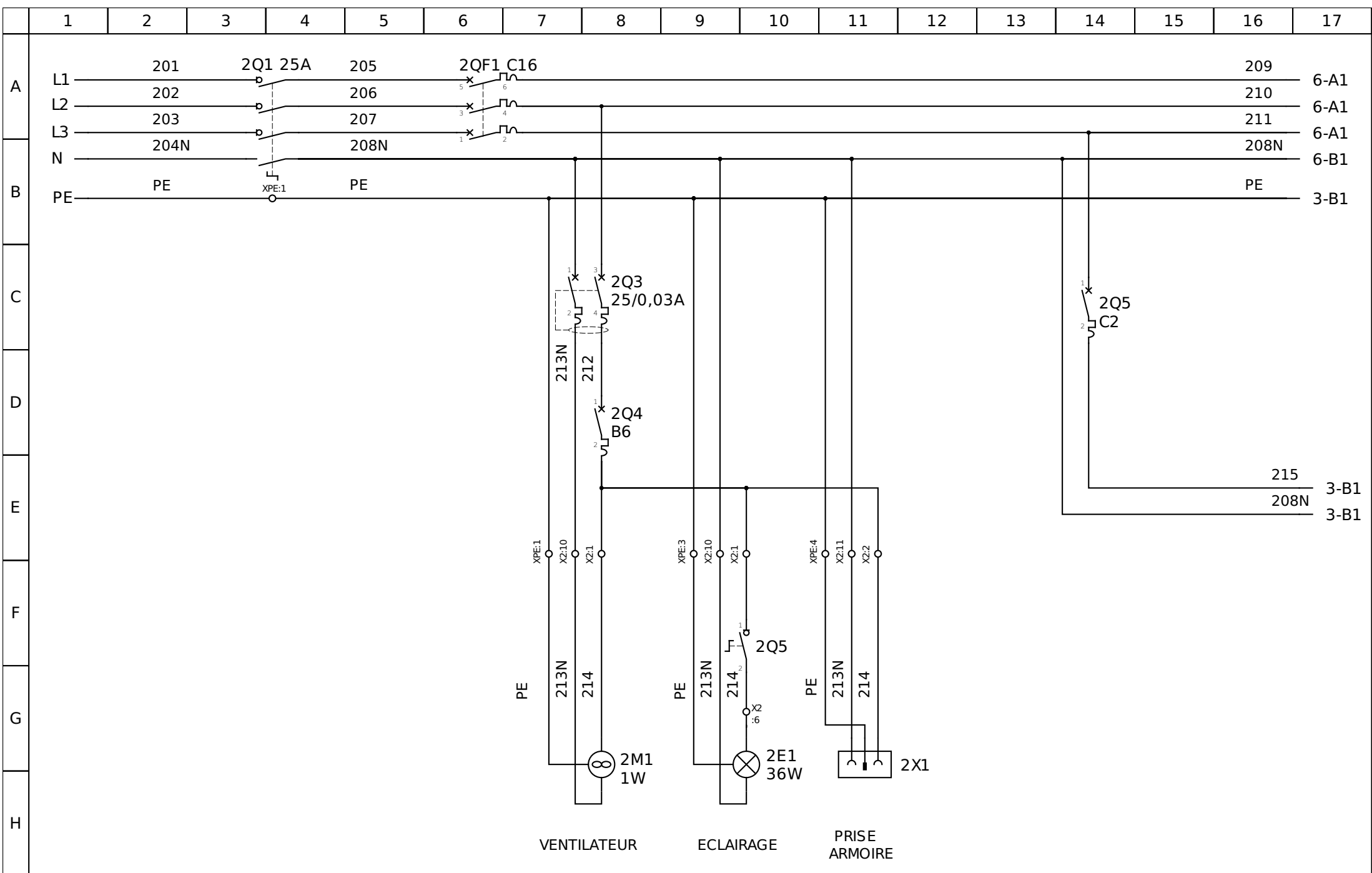

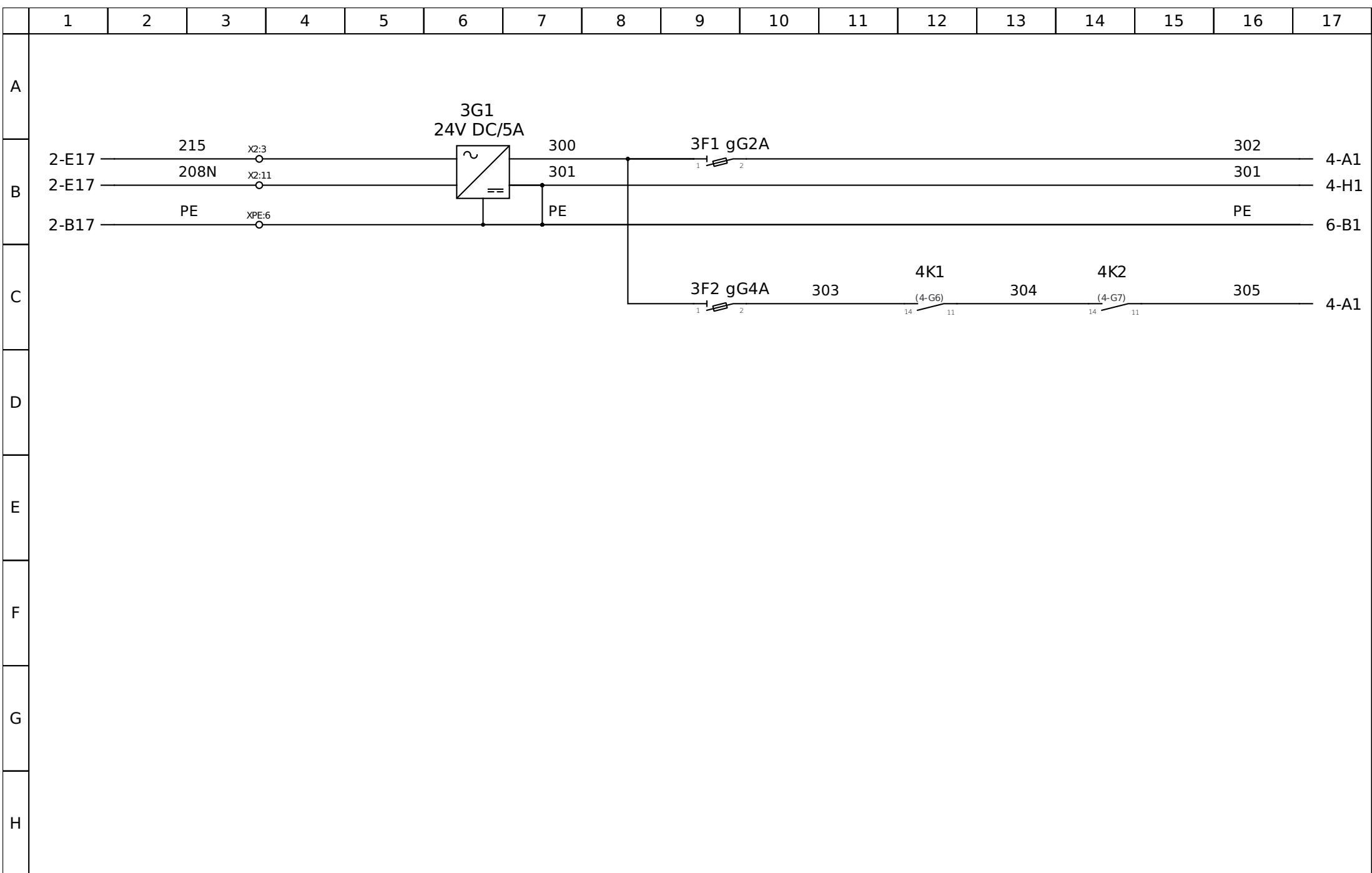



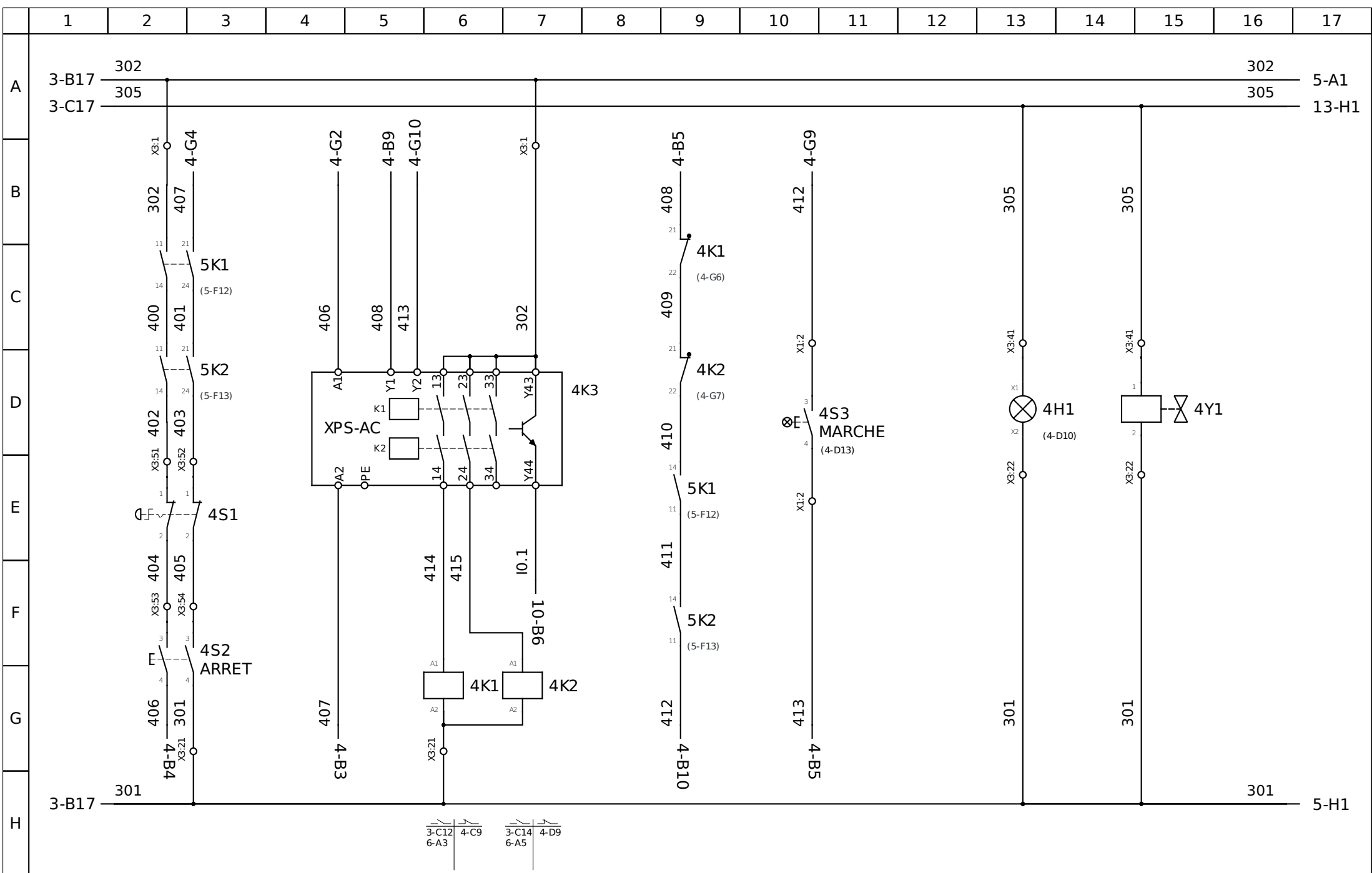

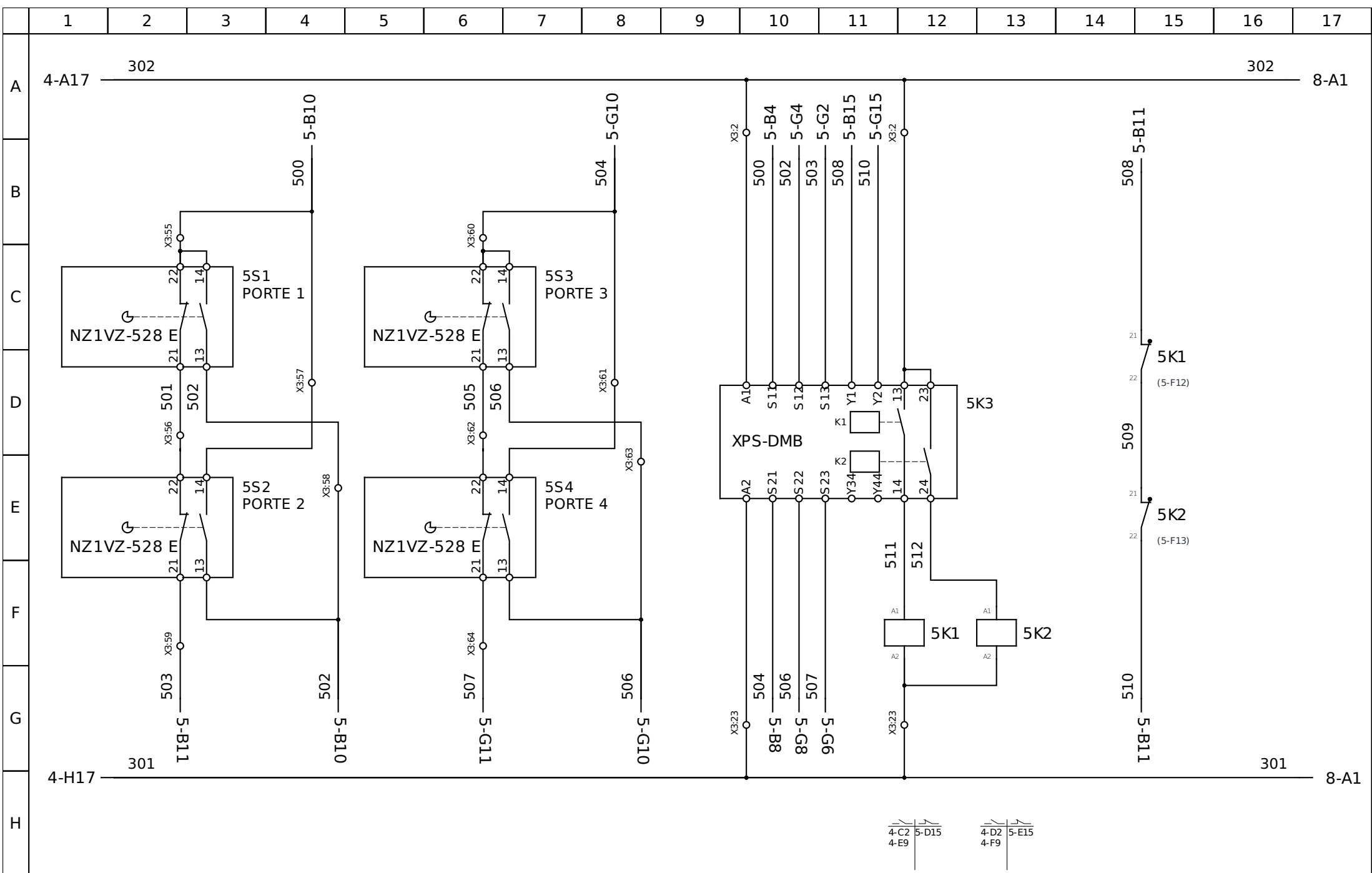

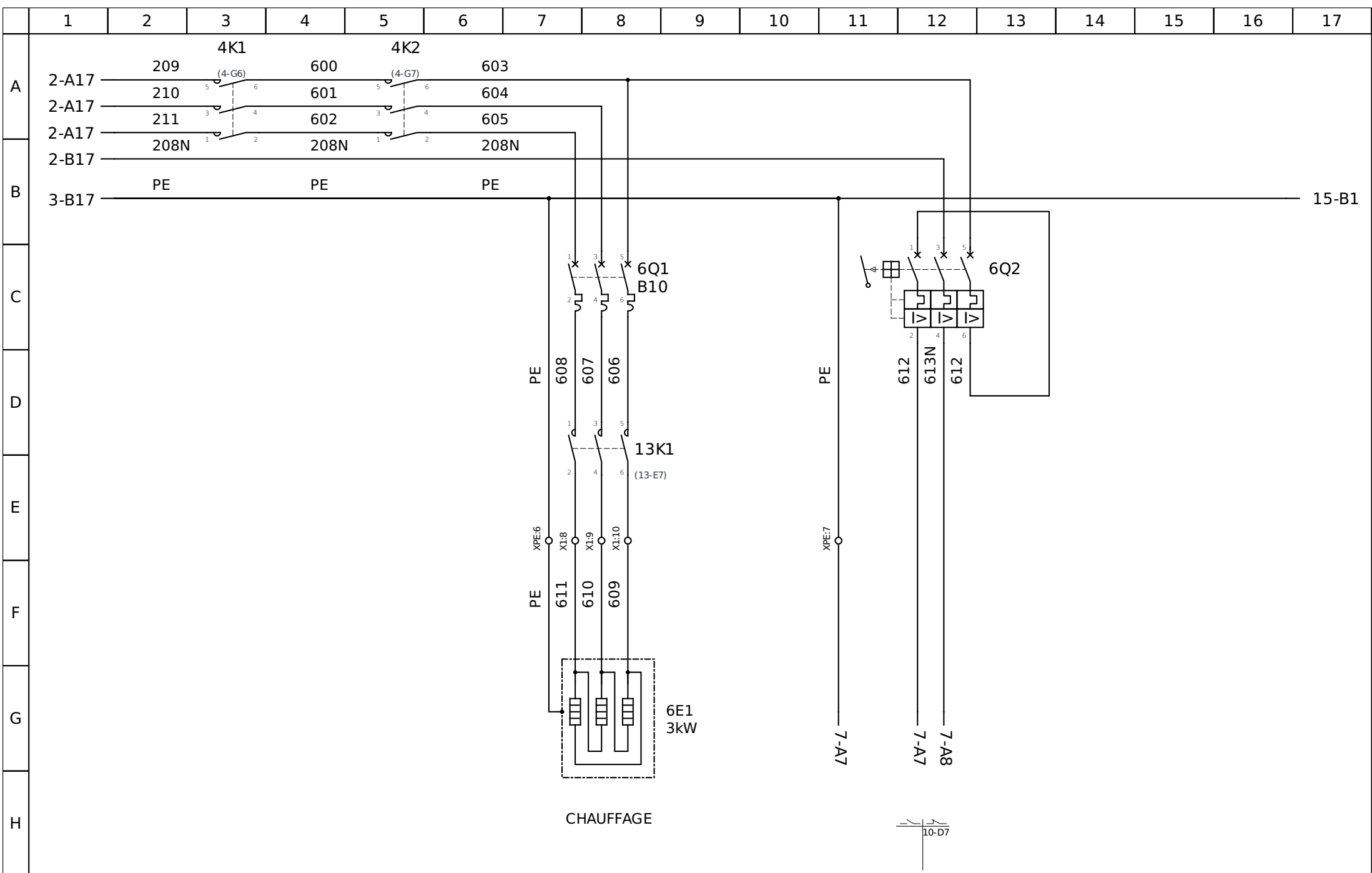

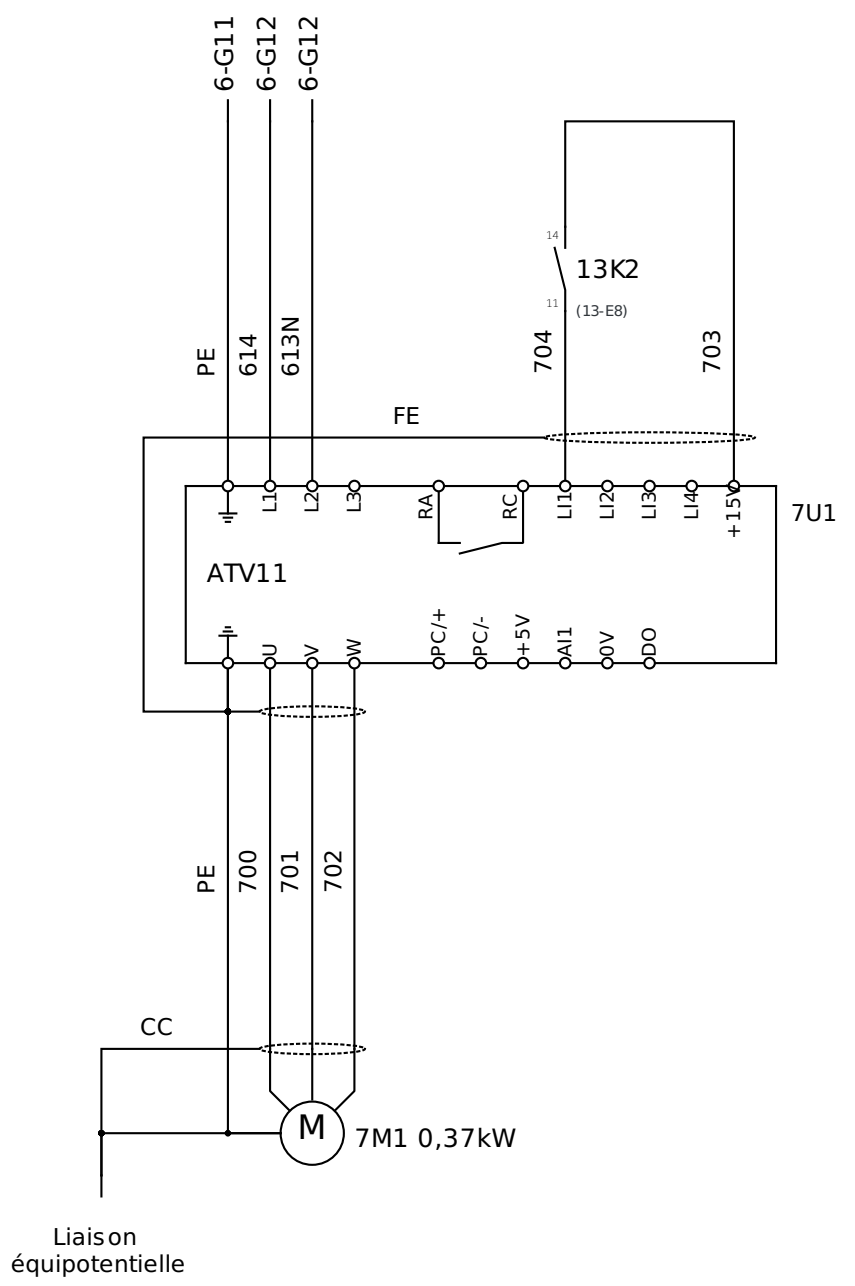

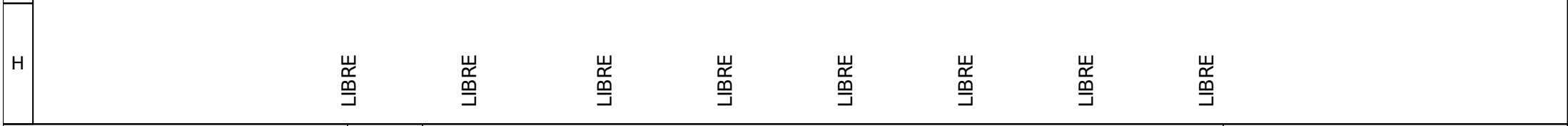
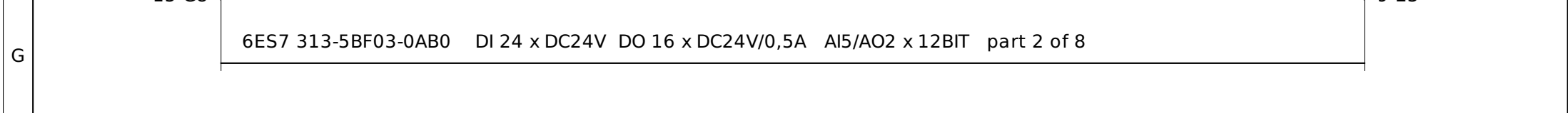
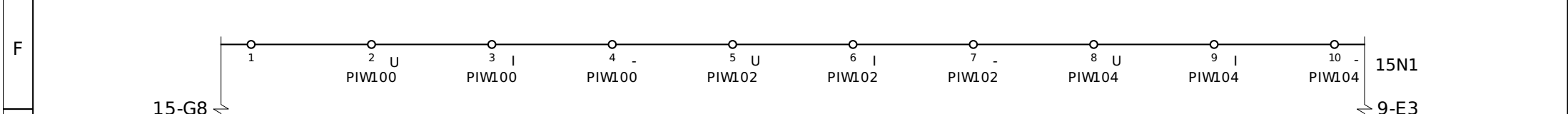
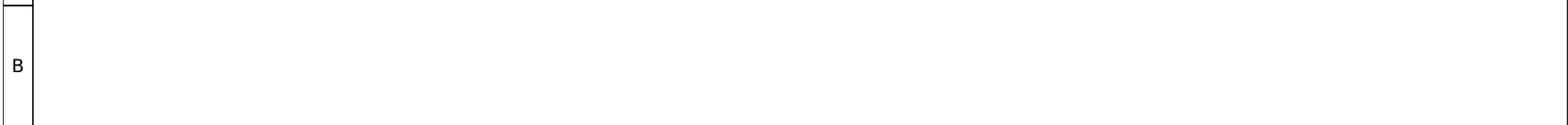
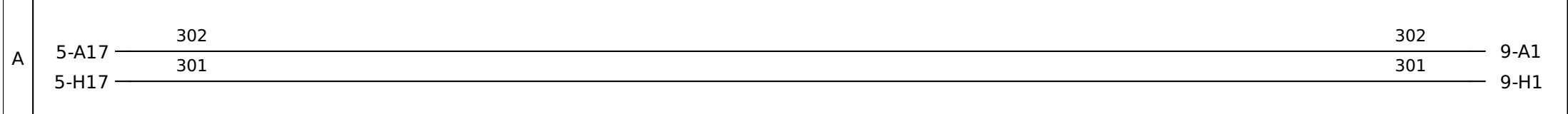



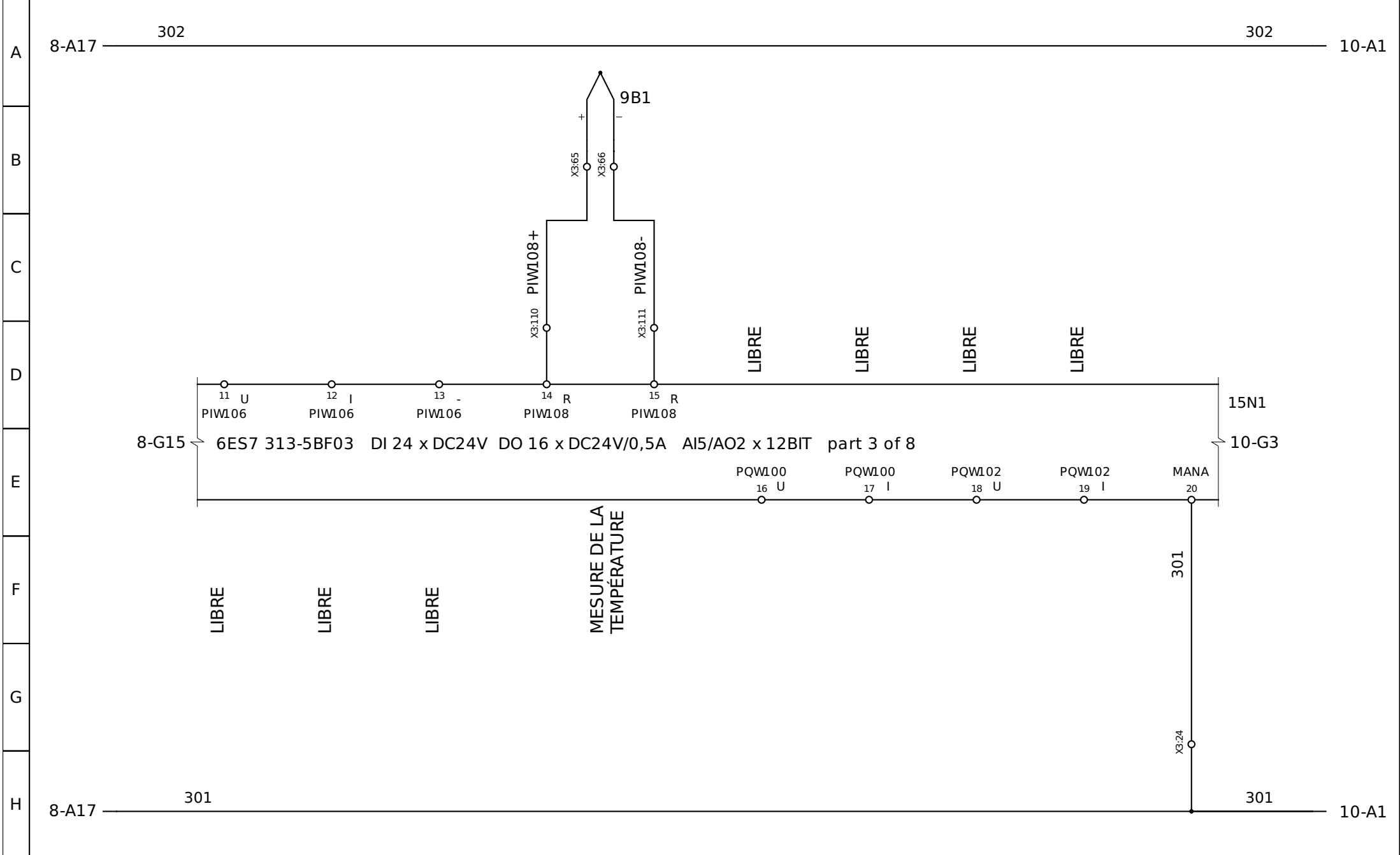

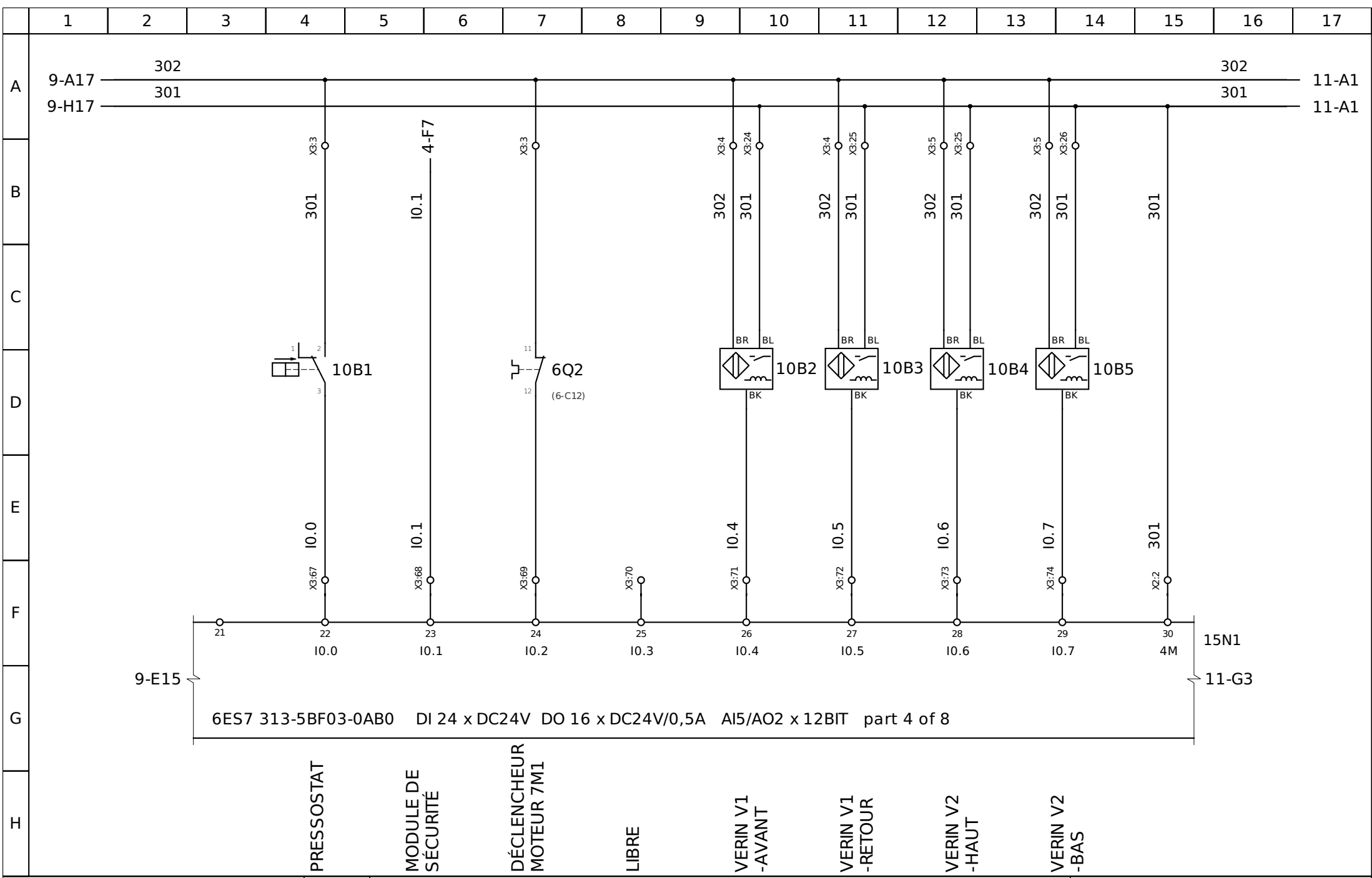

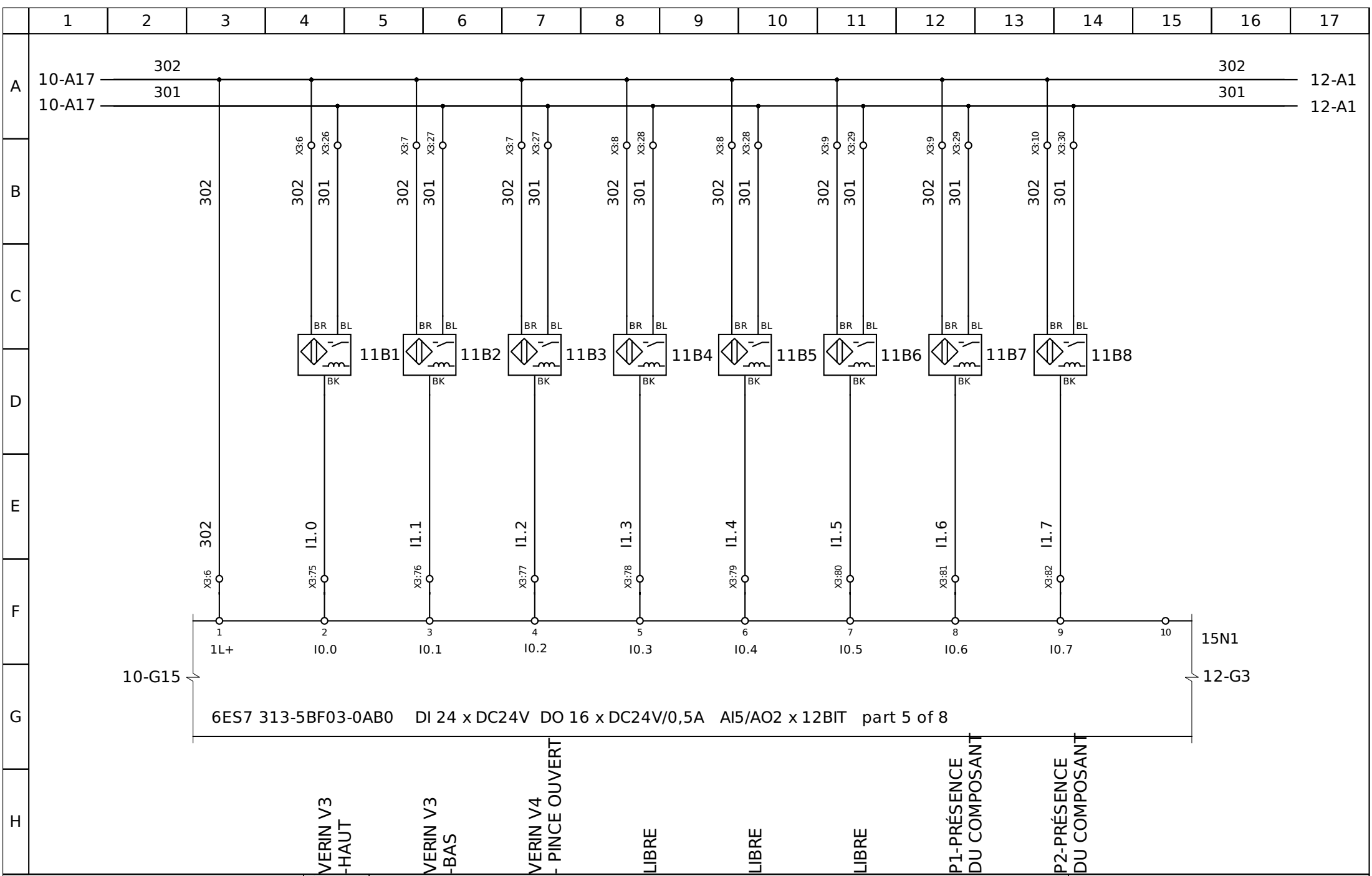

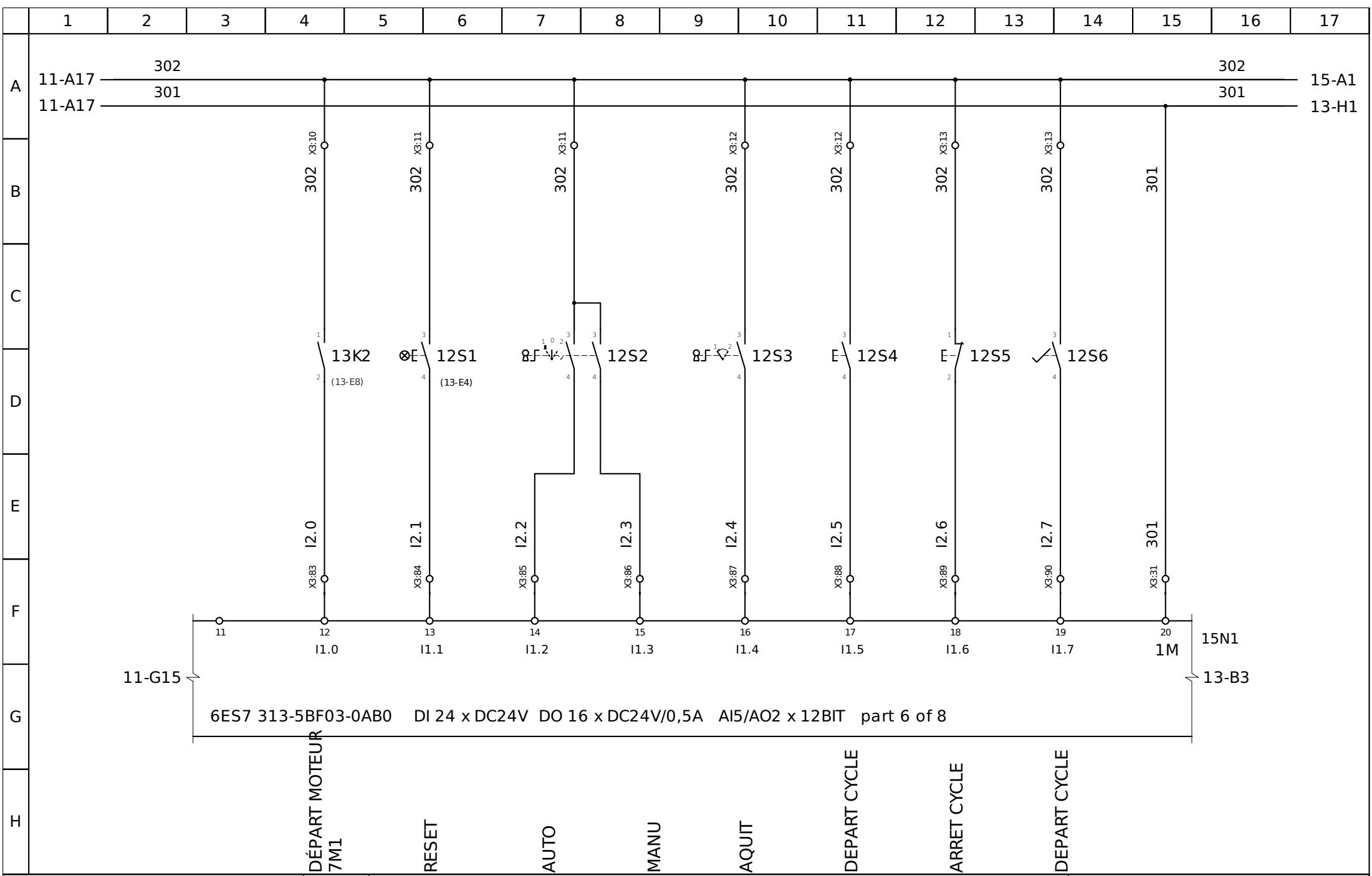

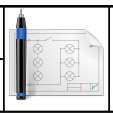
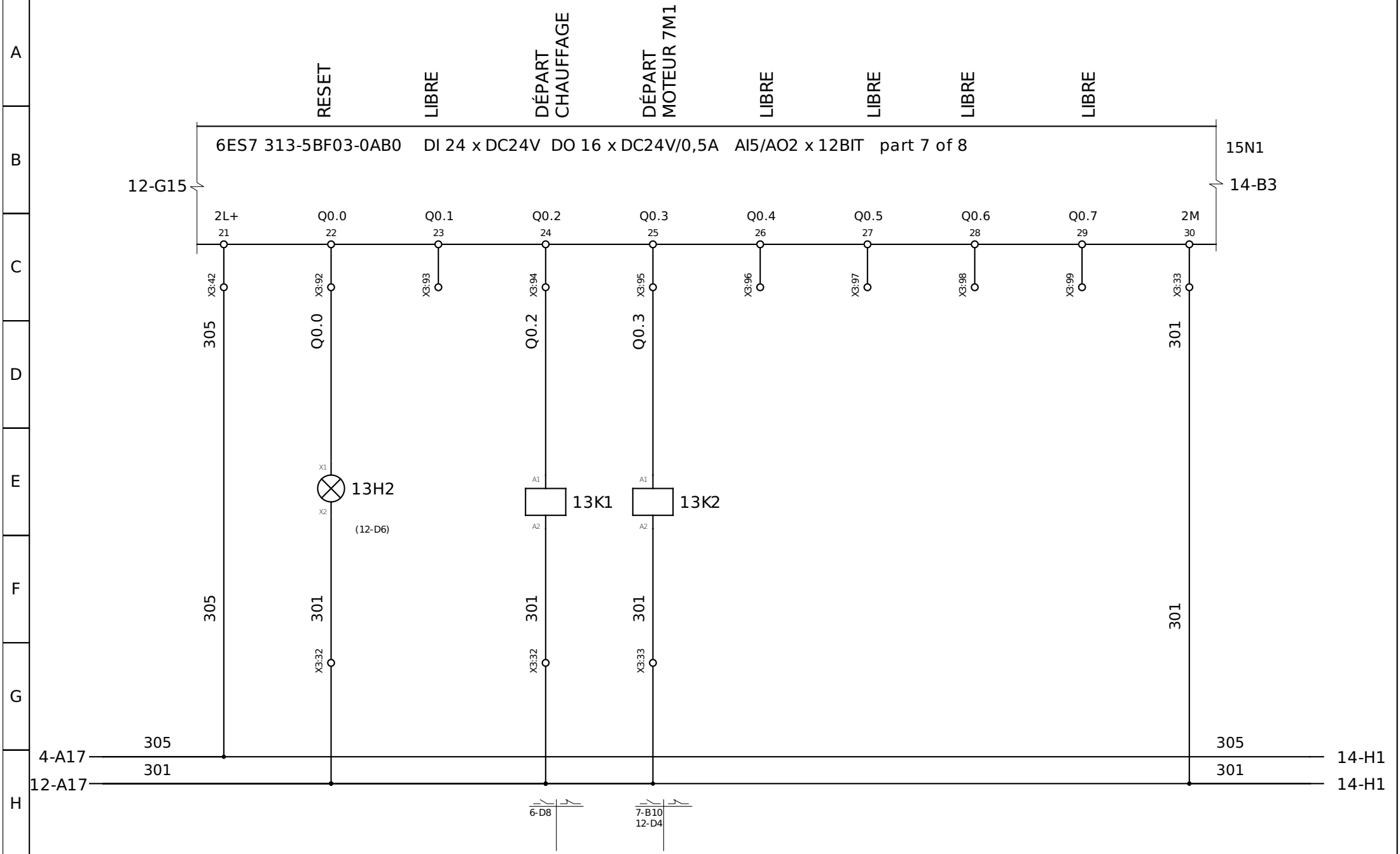

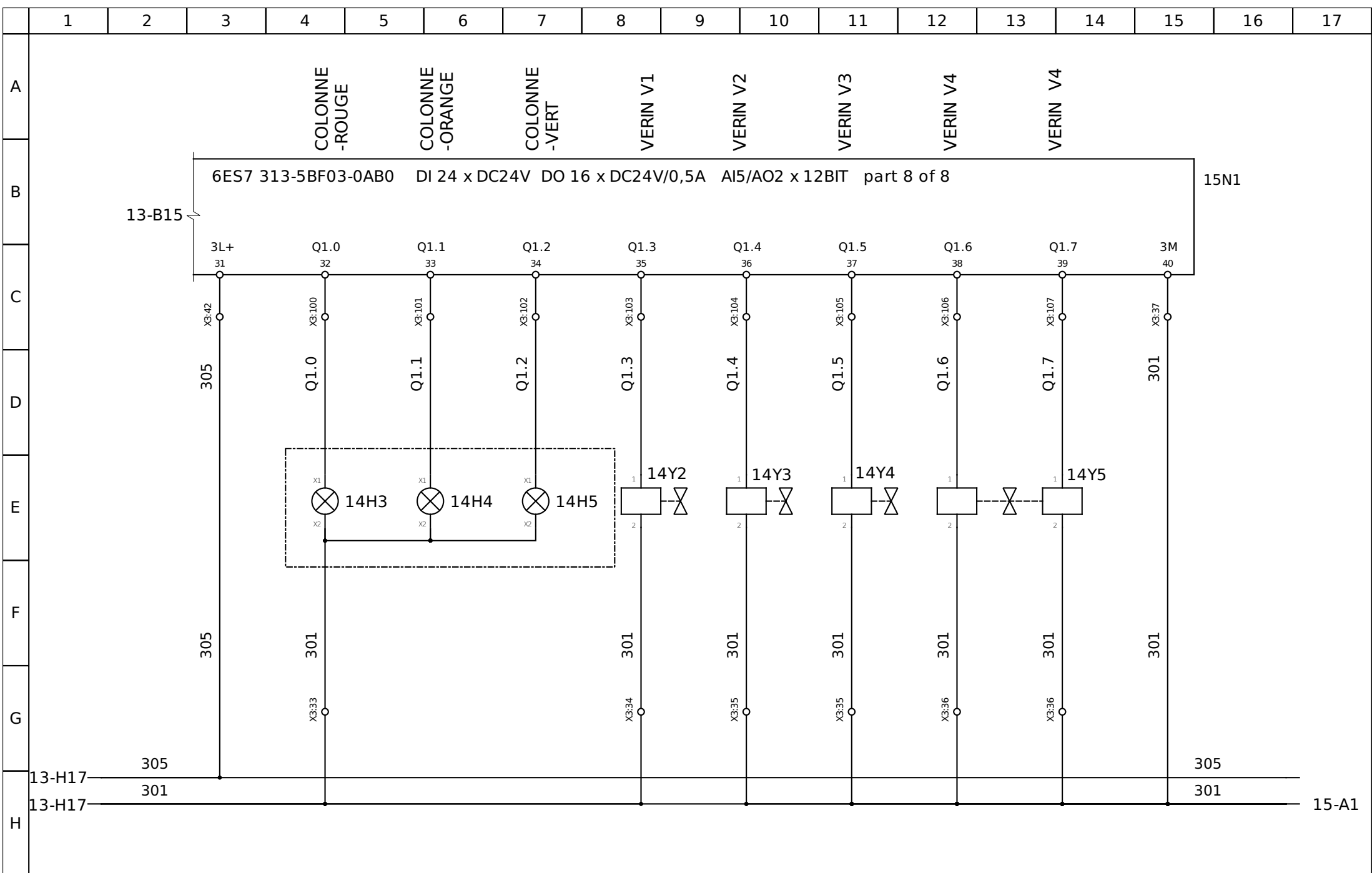

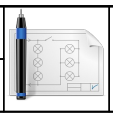
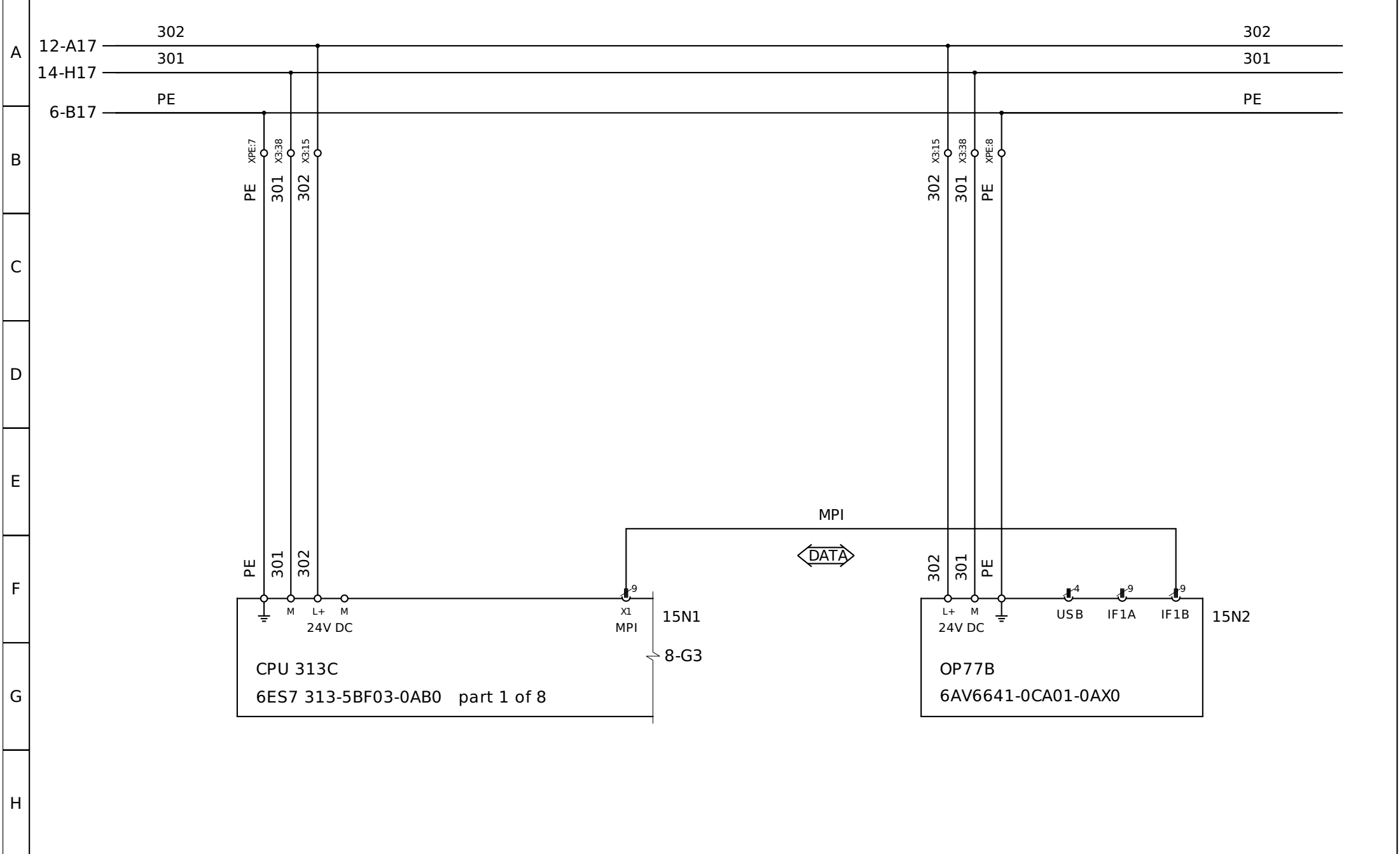

15N1

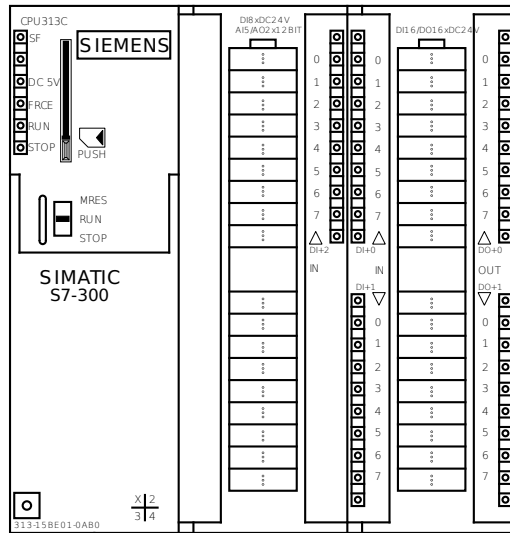

15N2

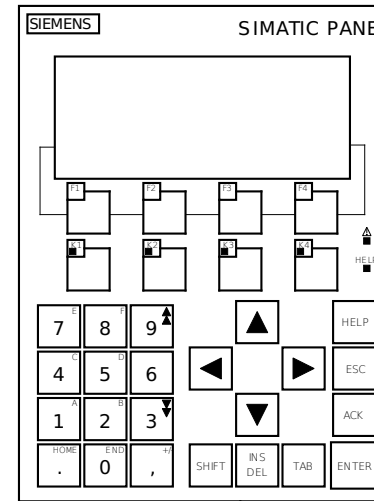

MPI





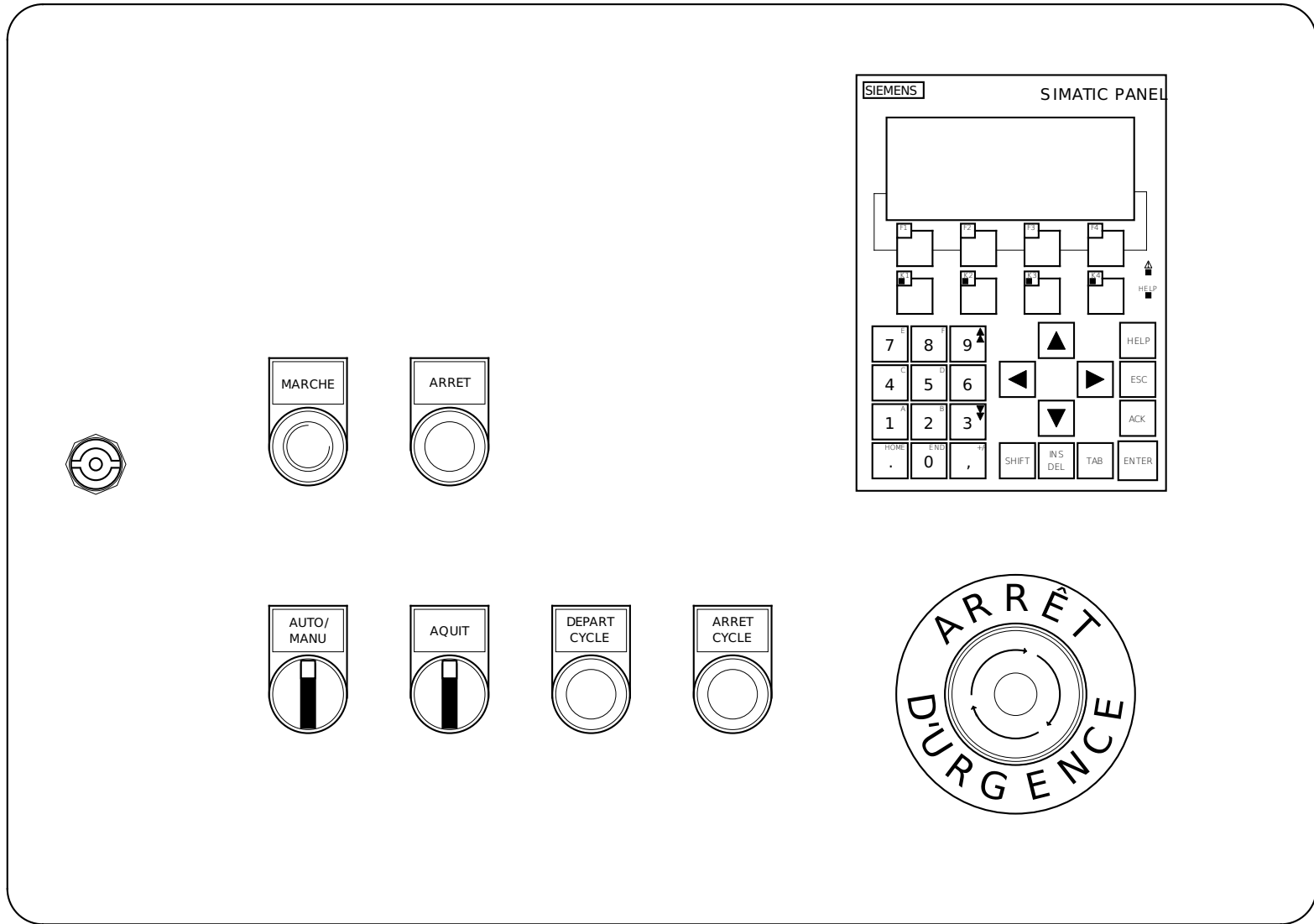

A

B

C

D

E

F

G

H

