

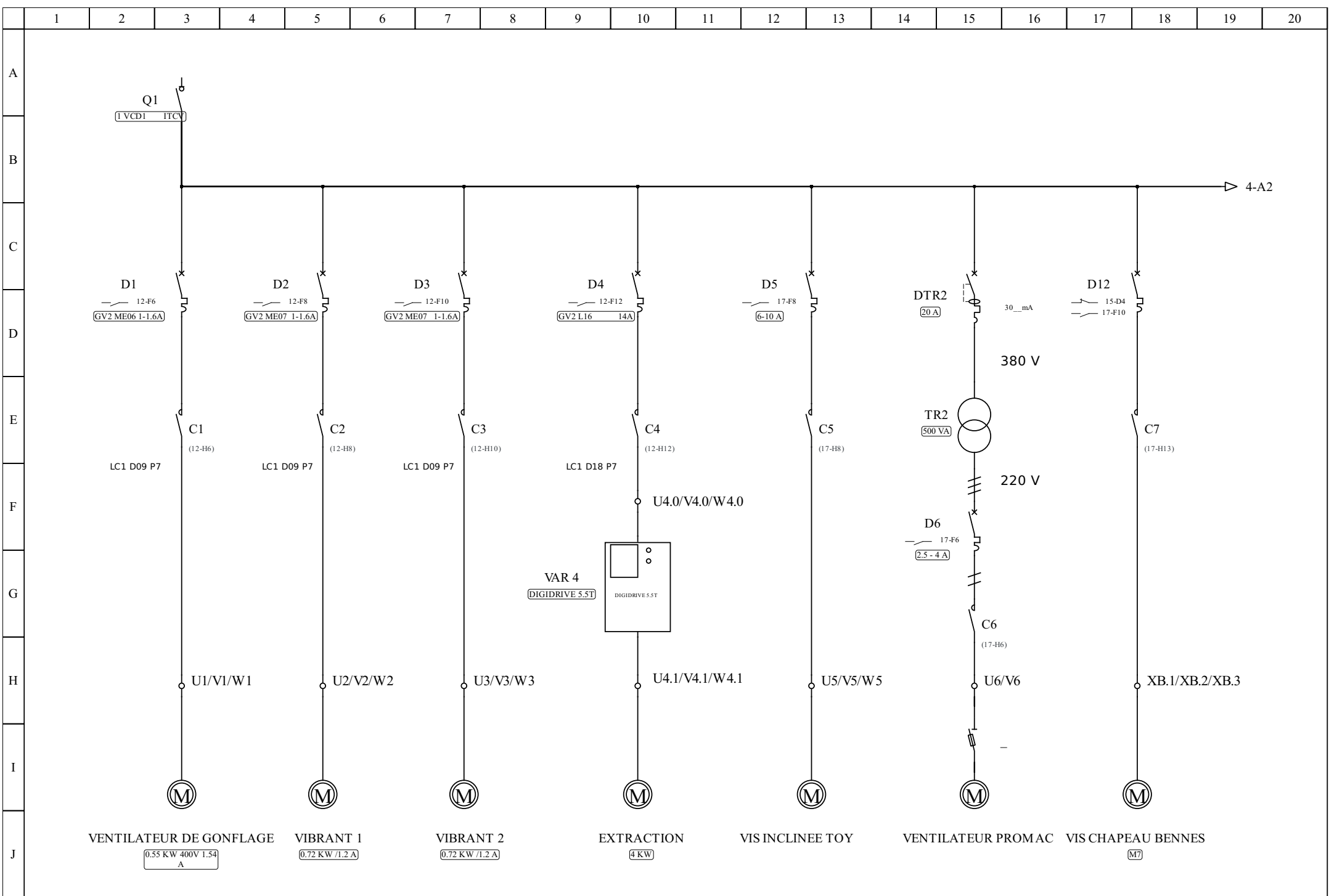

Folio	Titre	Auteur	Date
1	PAGE DE GARDE	LT	18/07/2015
2	Liste des Folios	LT	18/07/2015
3	PUISSANCE MOTEURS	LT	18/07/2015
4	ALIMENTATIONS GENERALES	LT	18/07/2015
5	ALIMENTATIONS 24 V DC	LT	18/07/2015
6	PREVENTA	LT	18/07/2015
7	SECURITEE AIR	LT	18/07/2015
8	AUTOMATE	LT	18/07/2015
9	FOLIO RESERVE	LT	18/07/2015
10	CARTE ENTREE 1/1	LT	18/07/2015
11	CARTE ENTREE 1/2	LT	18/07/2015
12	CARTE SORTIE 1/1	LT	18/07/2015
13	CARTE SORTIE 1/2	LT	18/07/2015
14	CARTE ENTREE 2/1	LT	18/07/2015
15	CARTE ENTREE 2/2	LT	18/07/2015
16	CARTE SORTIE 2/1	LT	18/07/2015
17	CARTE SORTIE 2/2	LT	18/07/2015
18	FOLIO RESERVE	LT	18/07/2015
19	SONDES VEGAVIB 61	LT	18/07/2015
20	VOYANTS	LT	18/07/2015
21	VARIATEUR VIS EXTRACTION	LT	18/07/2015
22	ELECTROVANNES	LT	18/07/2015
23	BASCULE PRECIA	LT	18/07/2015
24	BORNIERS	LT	18/07/2015
25	BORNIERS	LT	18/07/2015
26	FOLIO RESERVE	LT	18/07/2015
27	PALAN BENNES	LT	18/07/2015
28	ARMOIRE	LT	18/07/2015

Folio	Titre	Auteur	Date

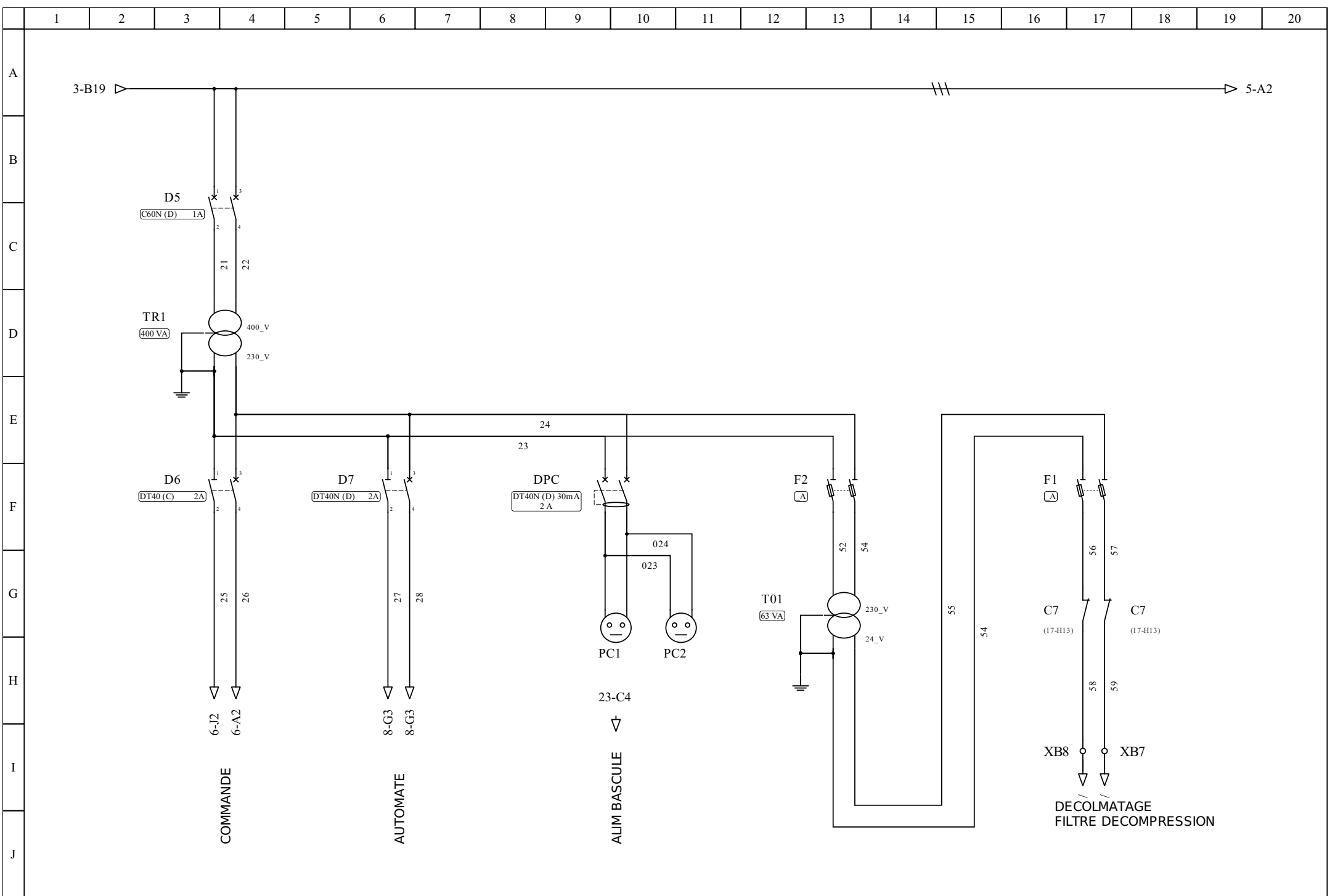



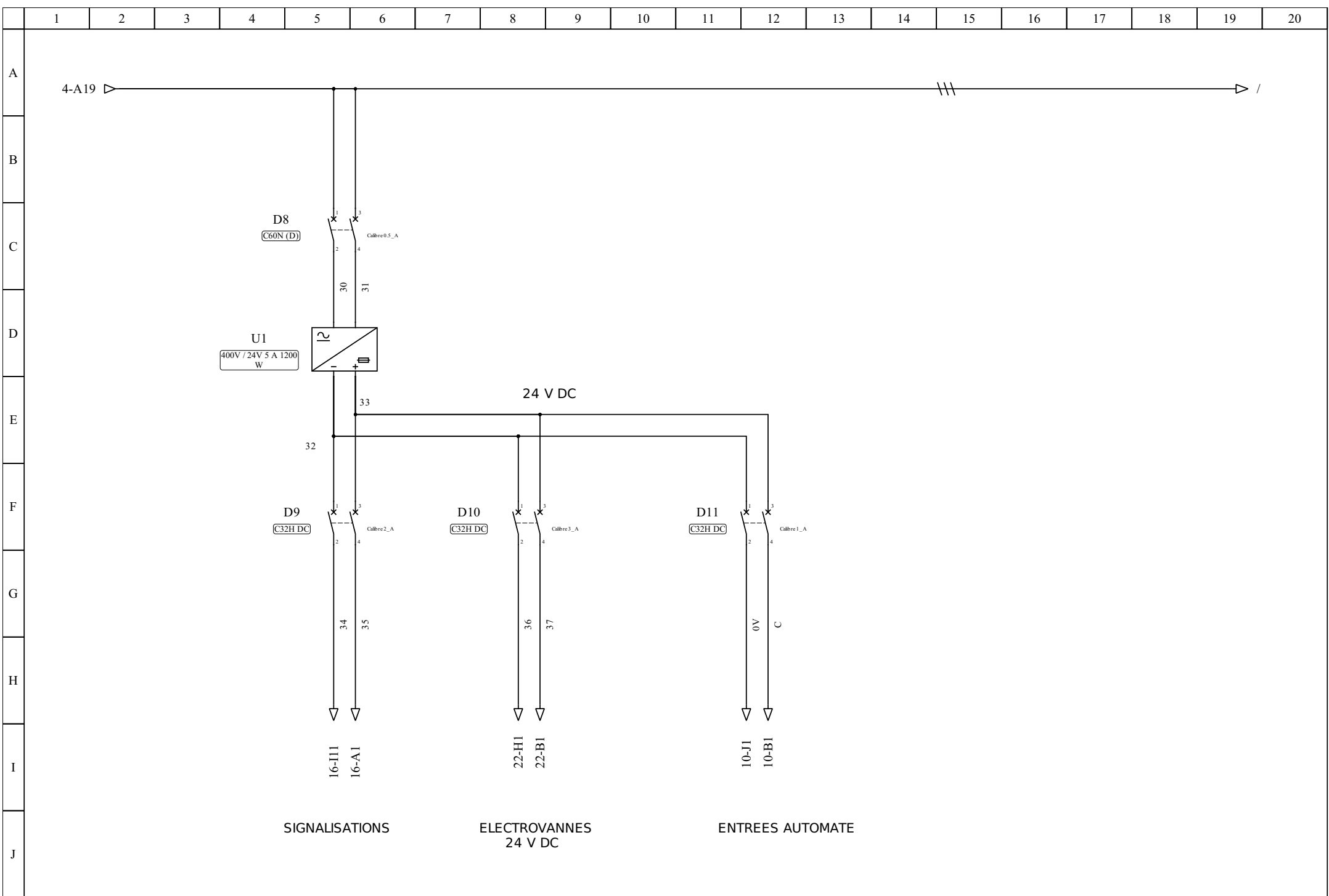

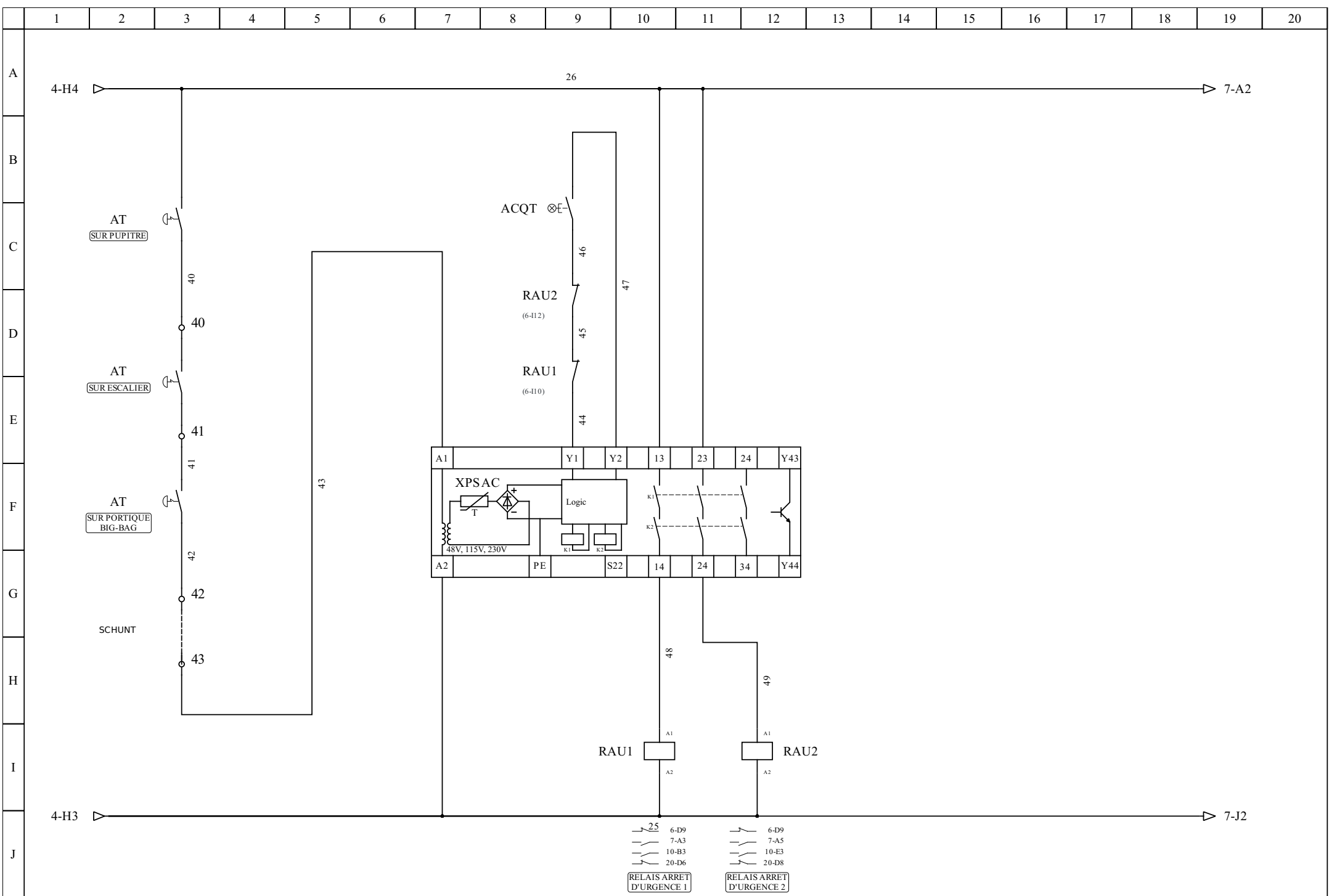

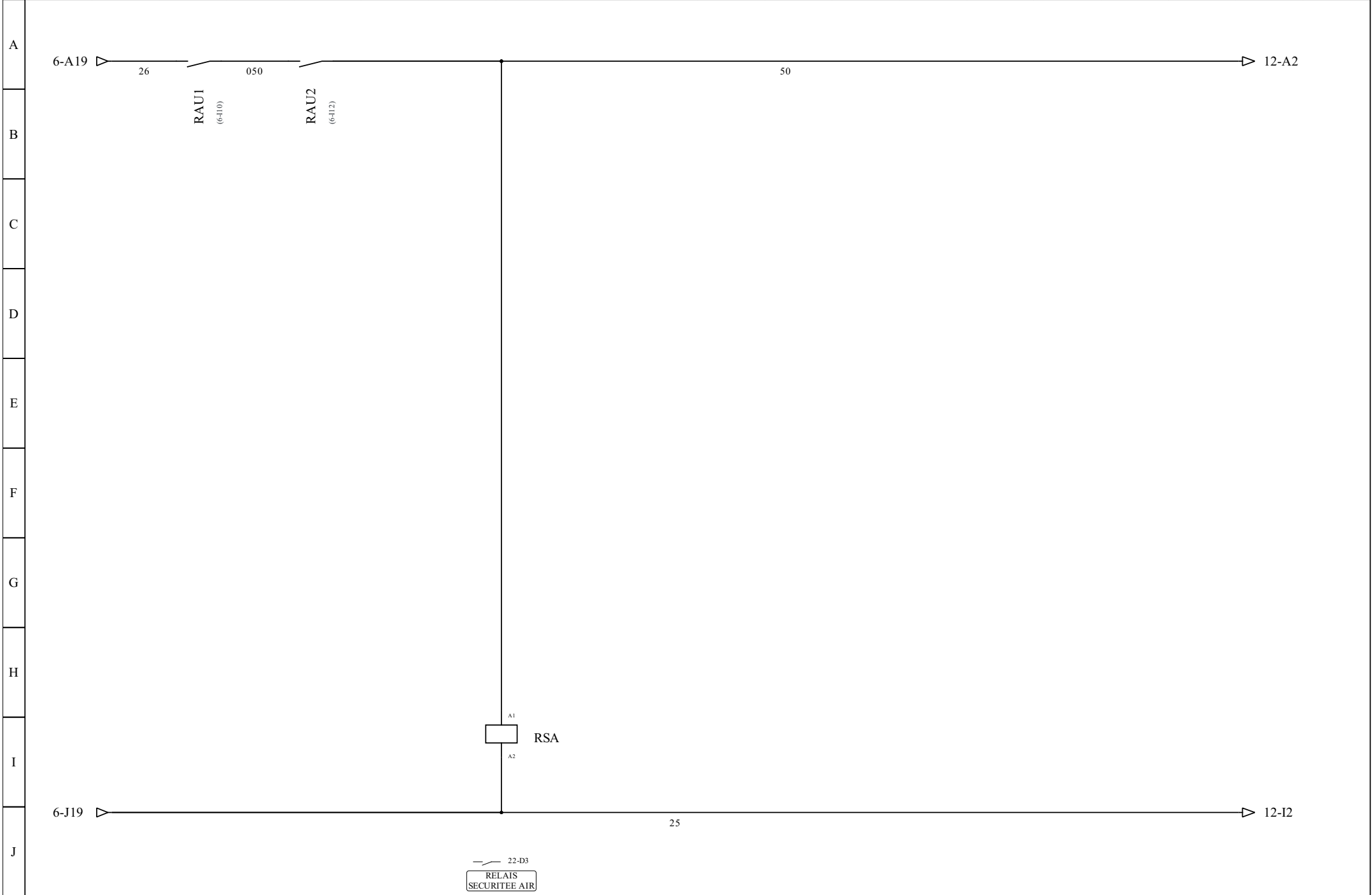

APIx                      RACKx                      TELEMECANIQUE                      TSX 37 21 001

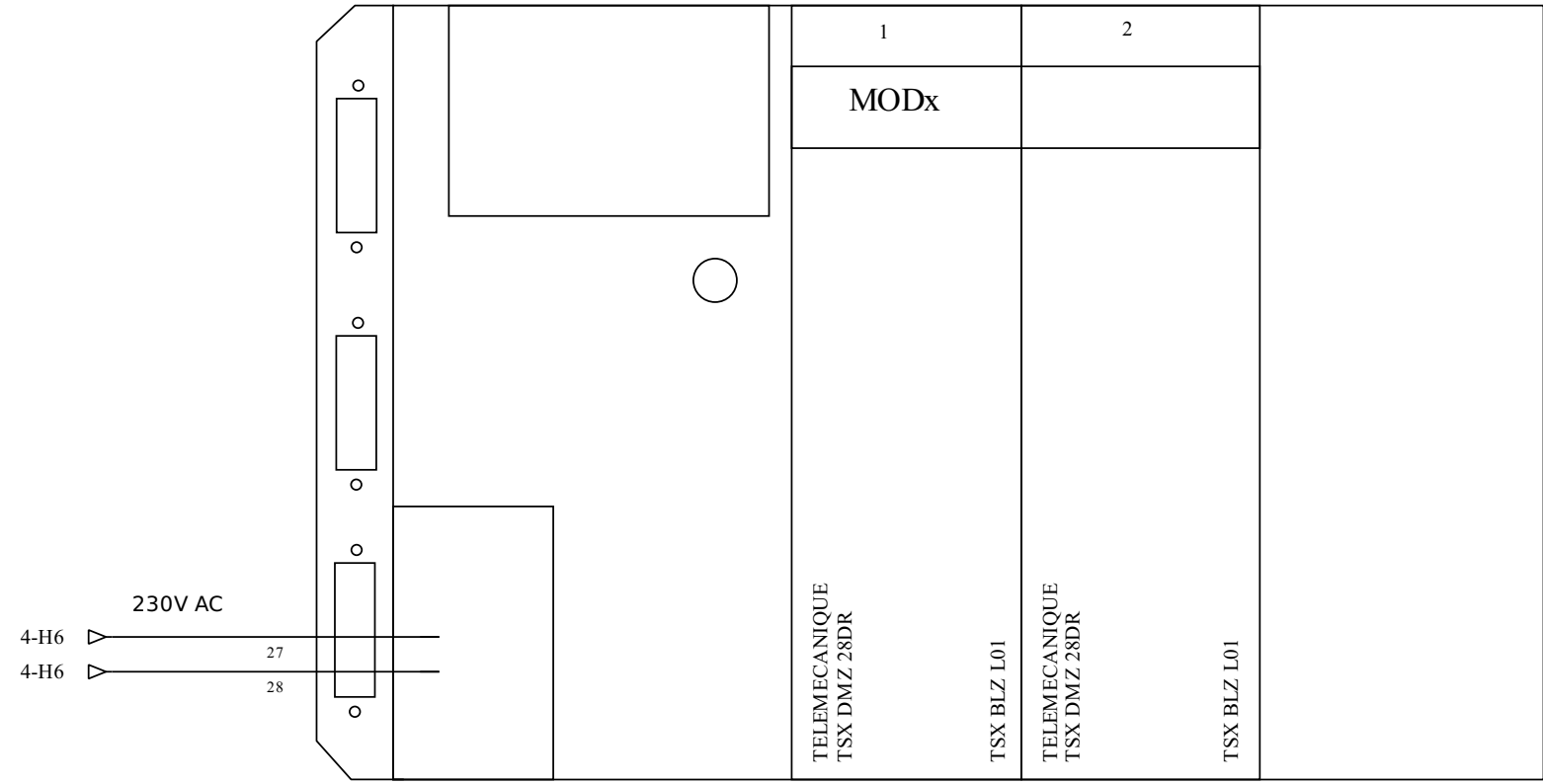



	1	2	3	4	5	6	7	8	9	10	11	12	13	14	15	16	17	18	19	20
A	<h1>FOLIO RESERVE</h1>																			
B																				
C																				
D																				
E																				
F																				
G																				
H																				
I																				
J																				

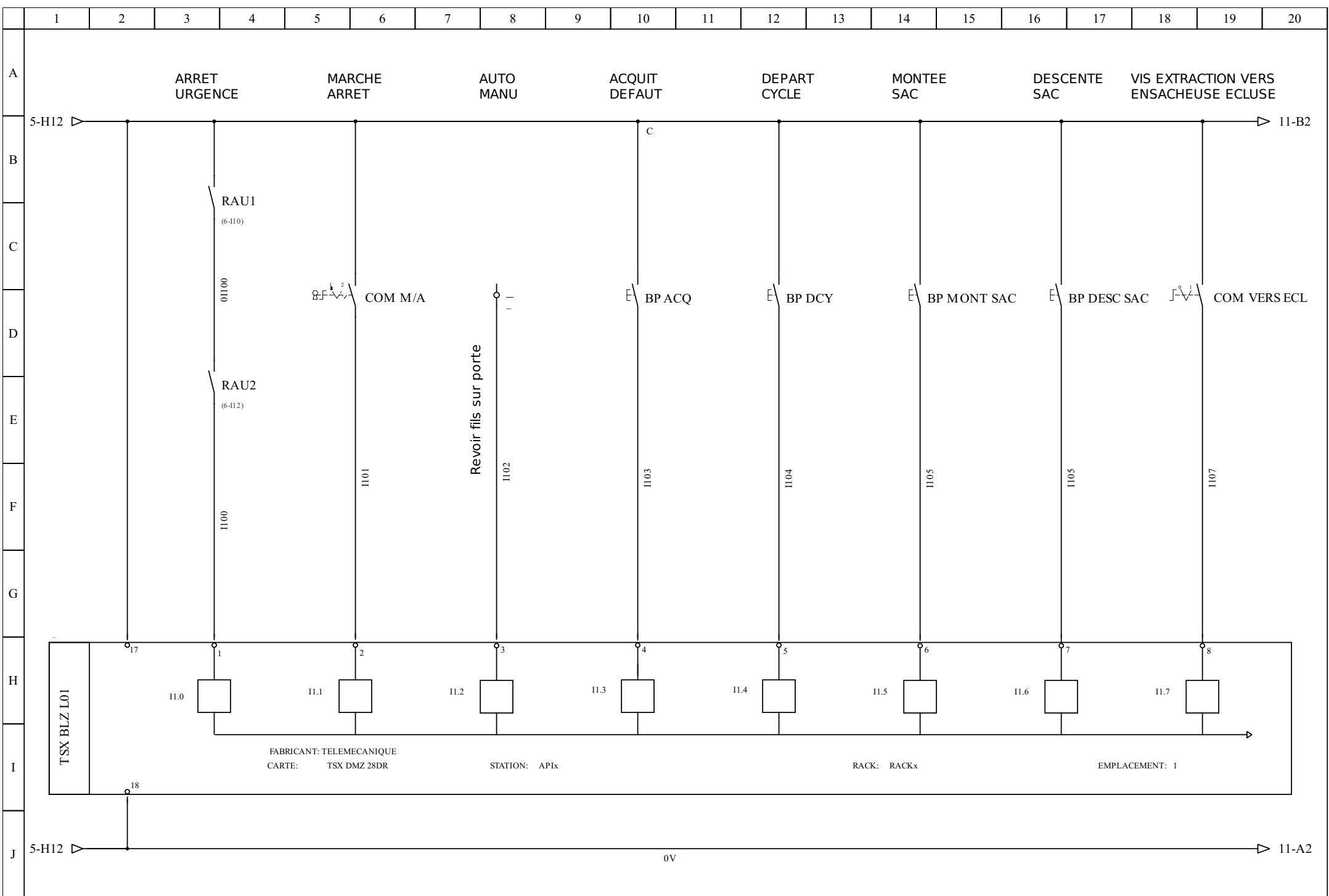

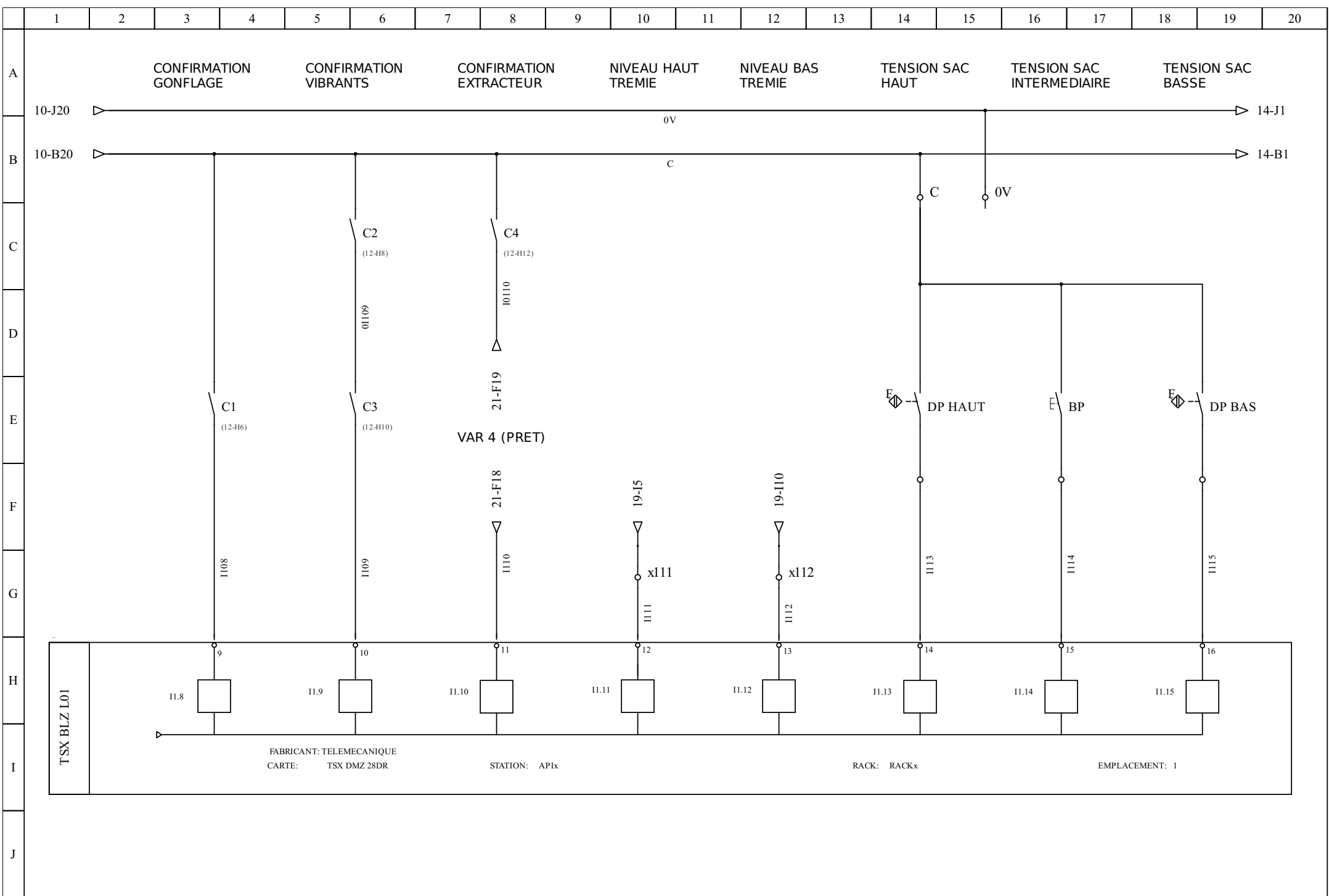

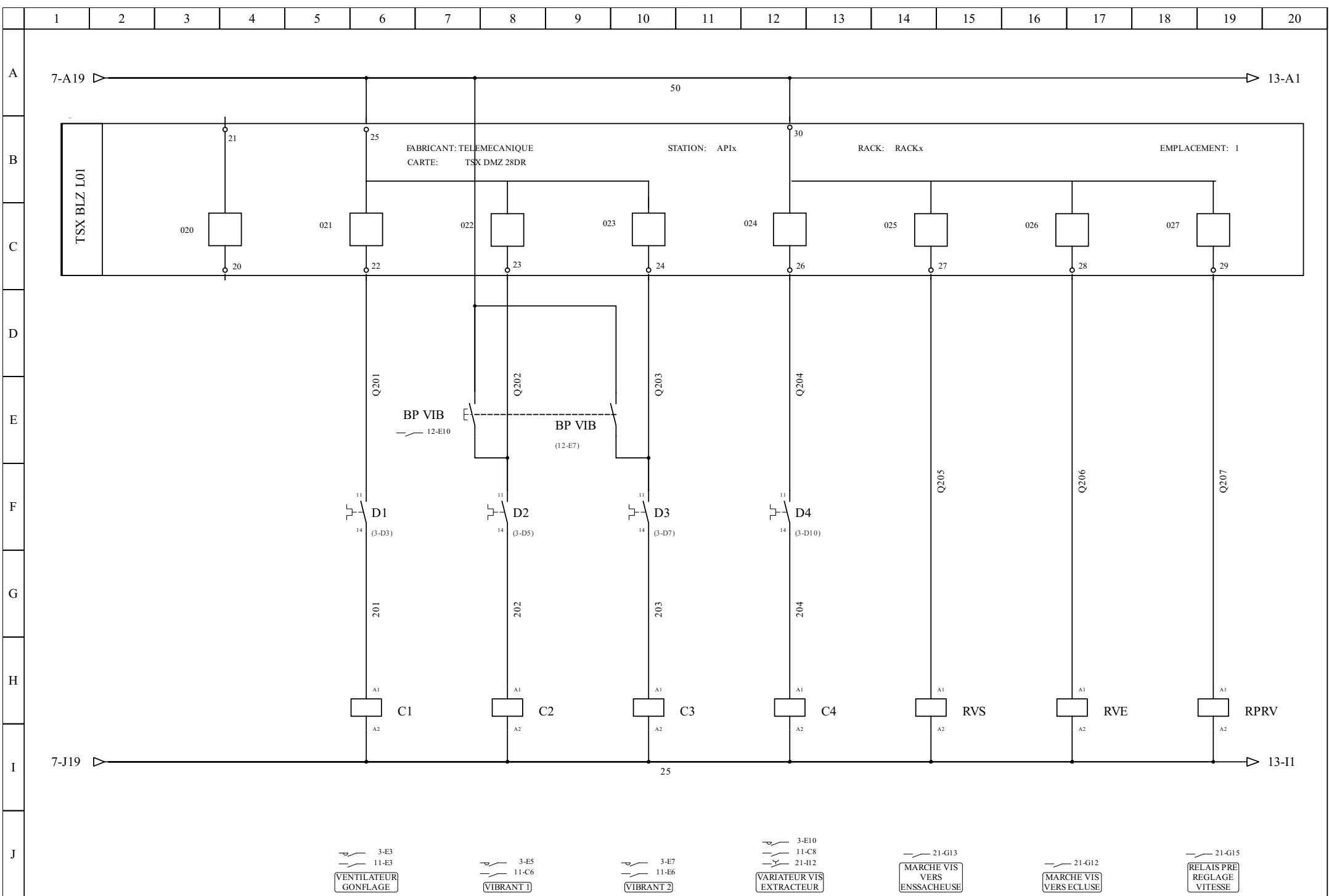

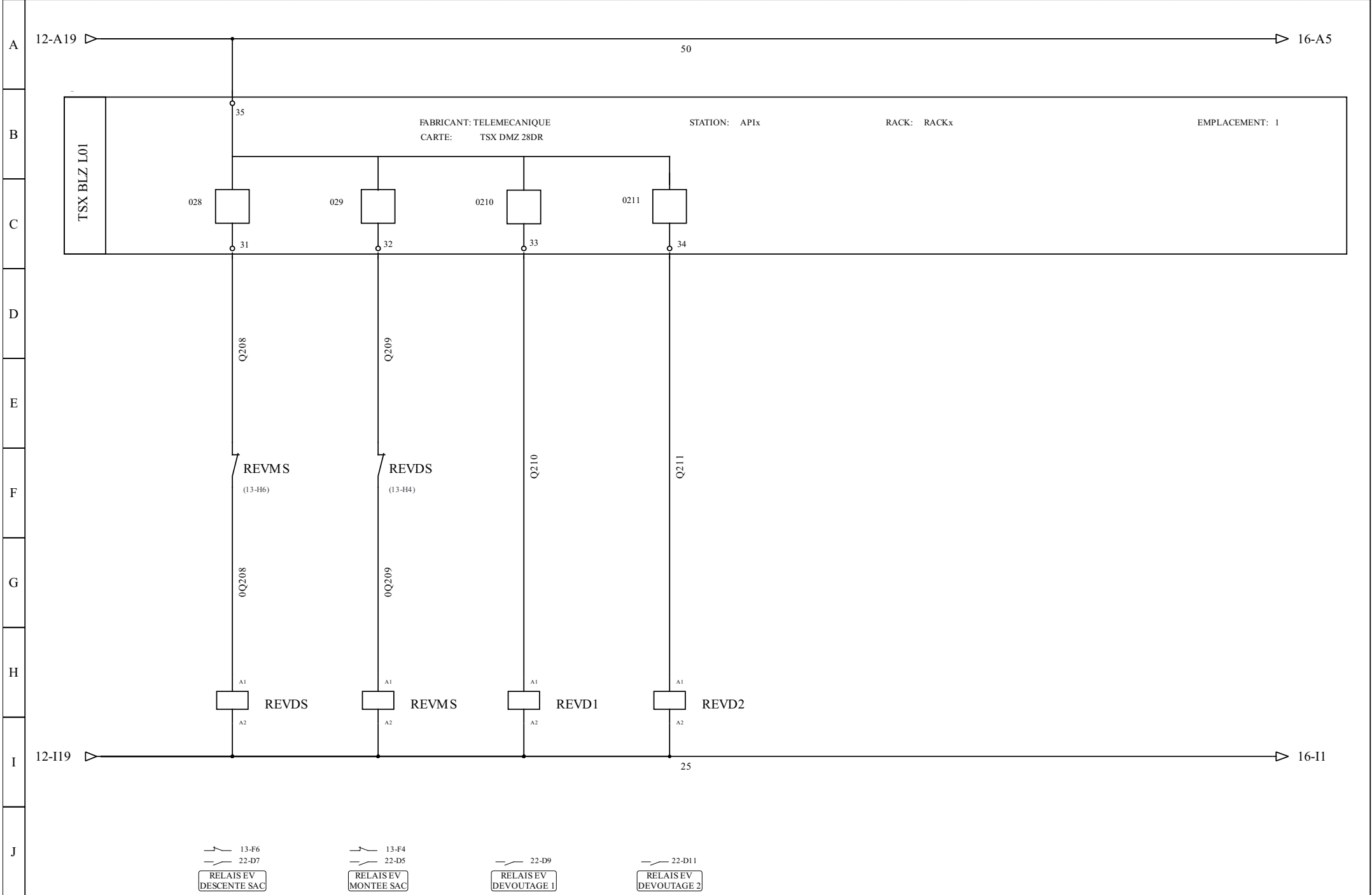

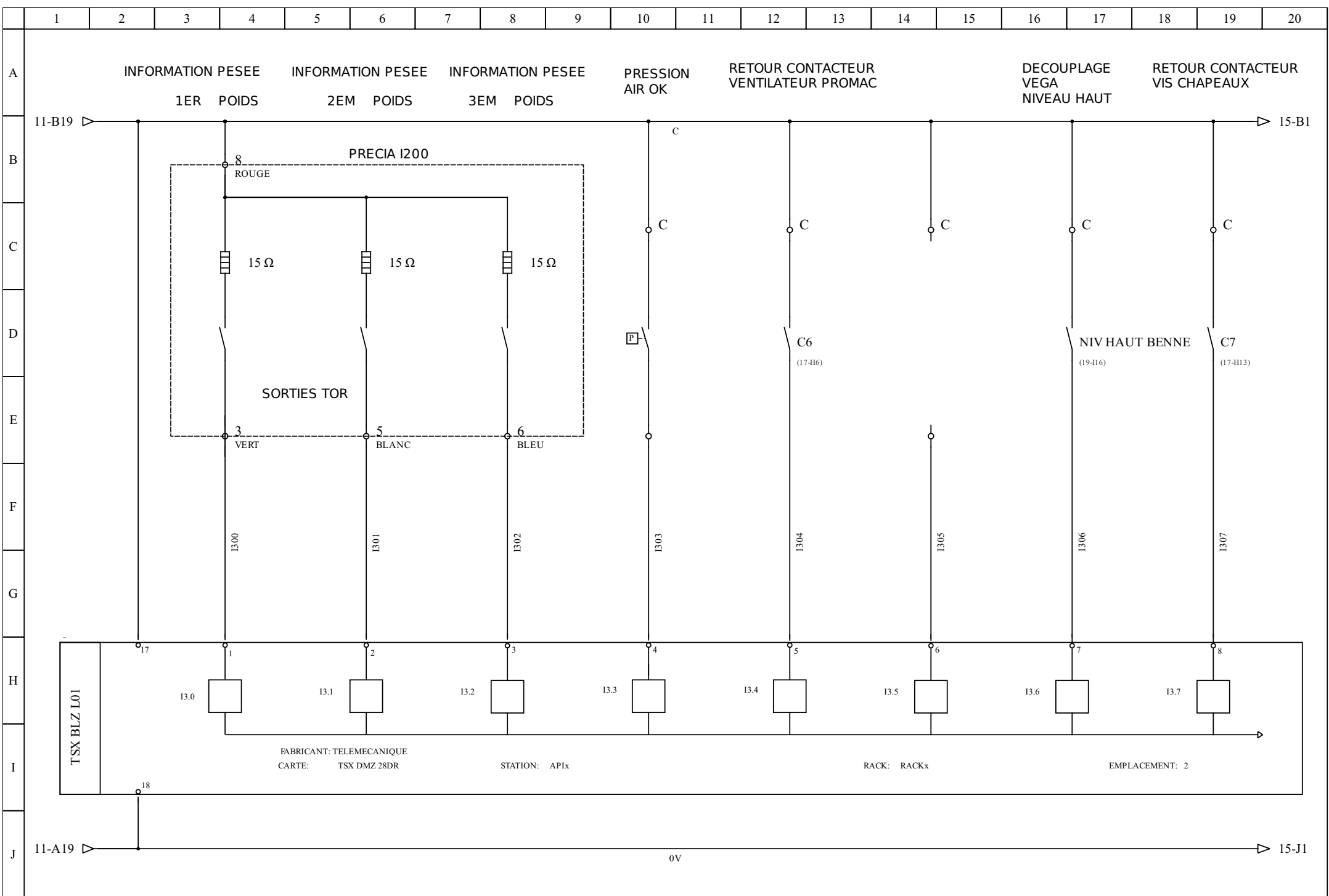

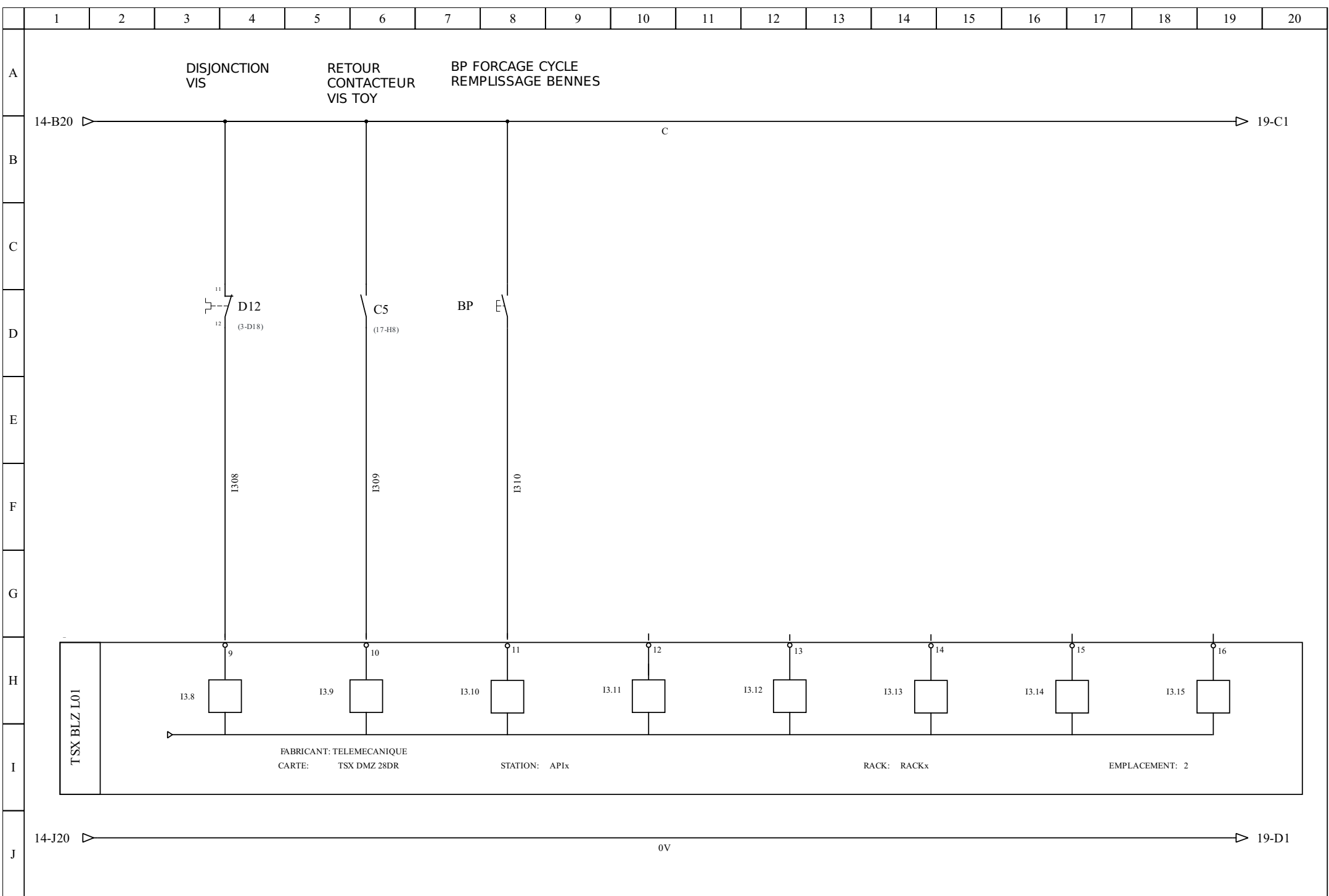

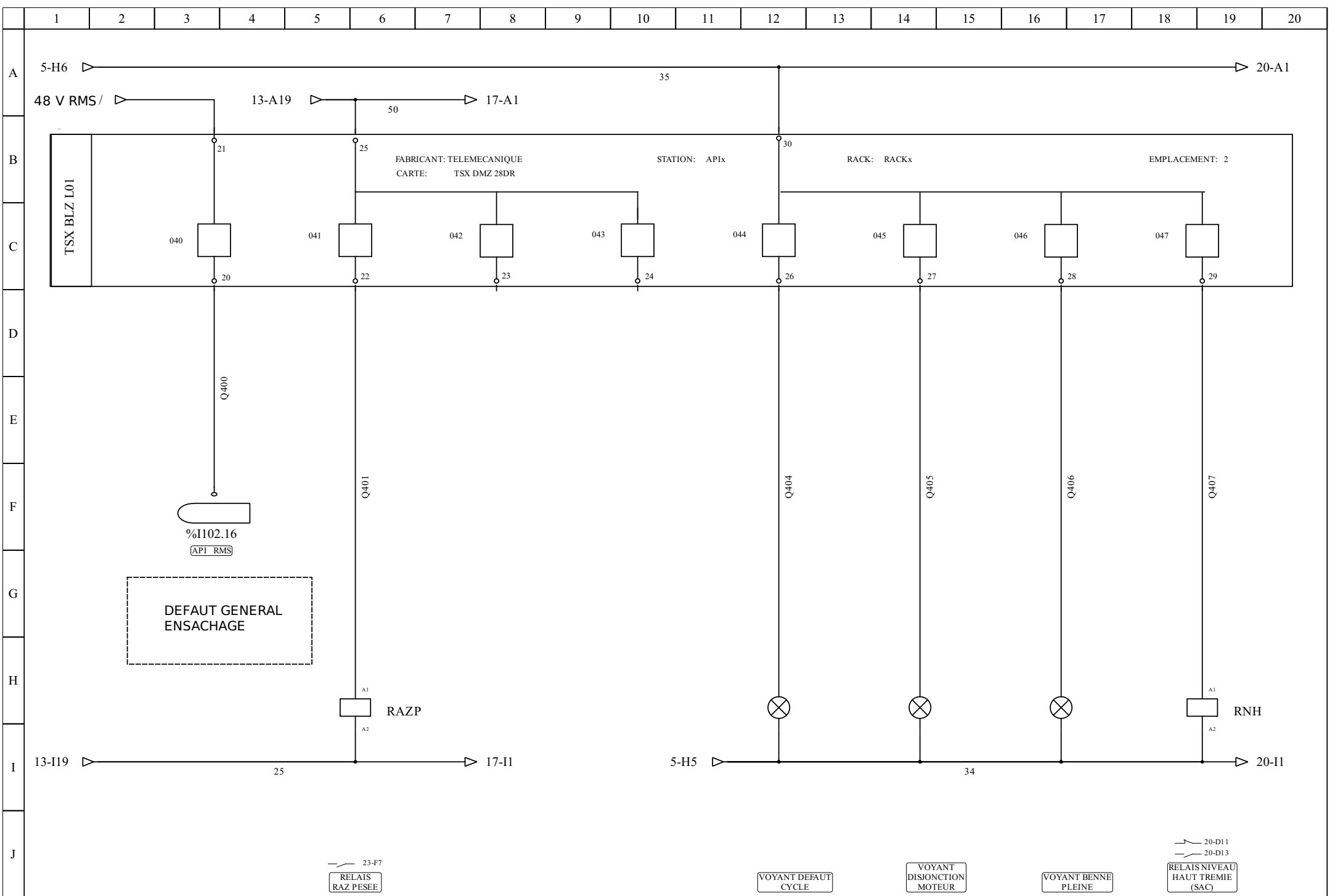



A  
B  
C  
D  
E  
F  
G  
H  
I  
J

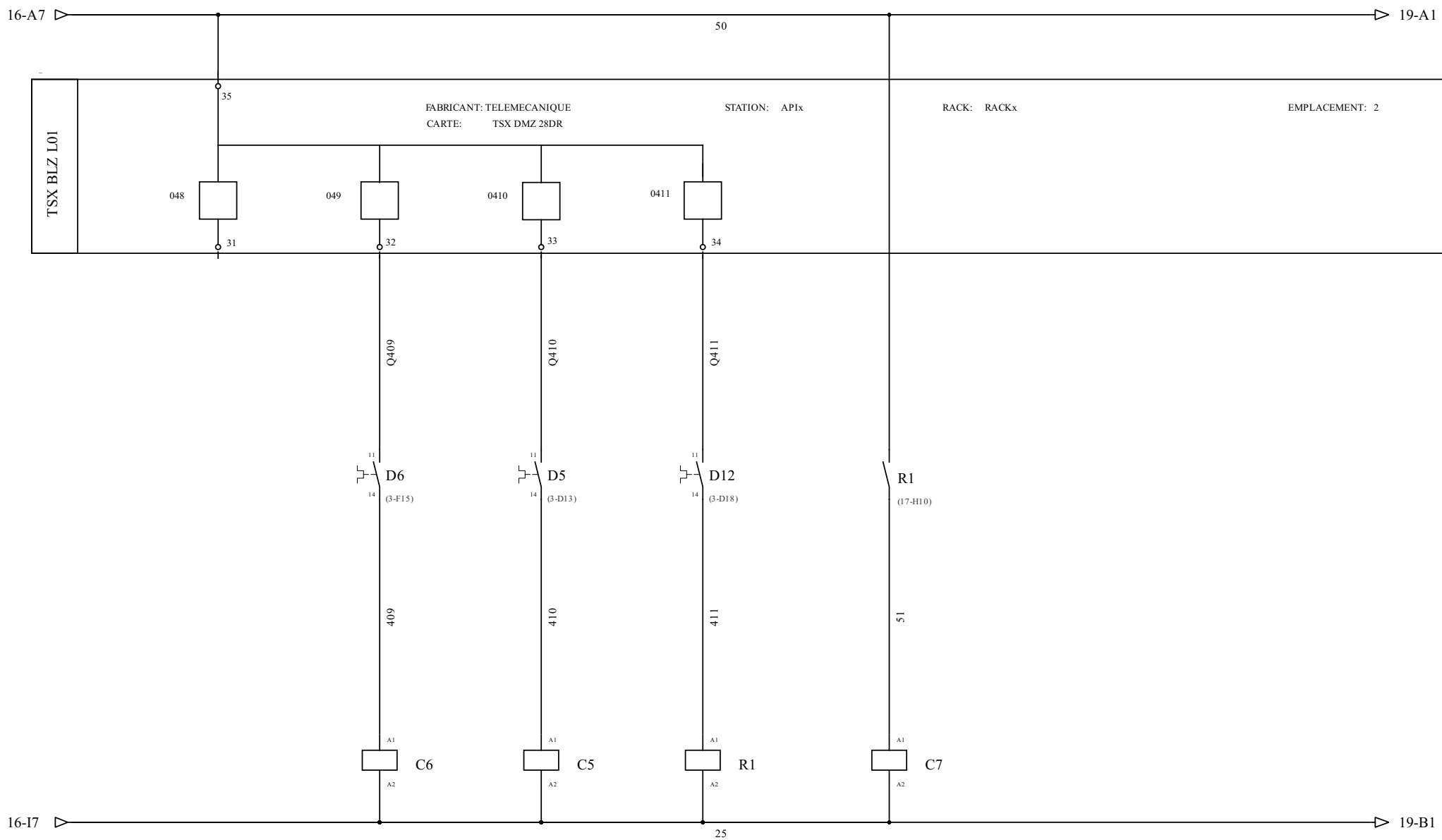

TSX BLZ L01

FABRICANT: TELEMECANIQUE  
CARTE: TSX DMZ 28DR

STATION: APIx

RACK: RACKx

EMPLACEMENT: 2

-  3-G15  
 14-D12  
 VENTILATEUR  
PROMAC
-  3-E13  
 15-D6  
 VIS INCLINEE  
TOY
-  17-F13  
 DECOUPLAGE VIS  
BENNES
-  3-E18  
 4-G17  
 4-G17  
 14-D19  
 VIS BENNES

	1	2	3	4	5	6	7	8	9	10	11	12	13	14	15	16	17	18	19	20
A	<h1>FOLIO RESERVE</h1>																			
B																				
C																				
D																				
E																				
F																				
G																				
H																				
I																				
J																				

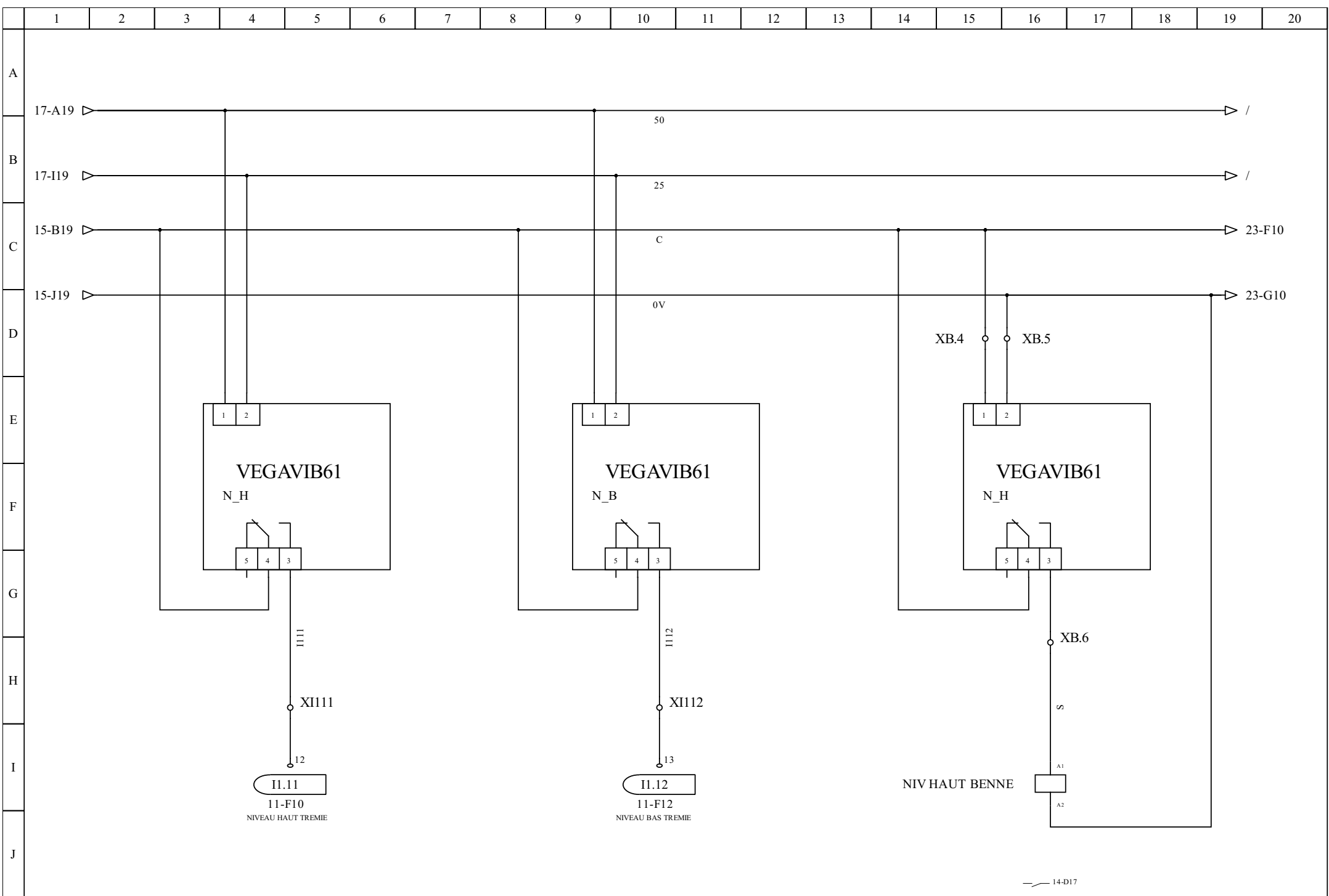

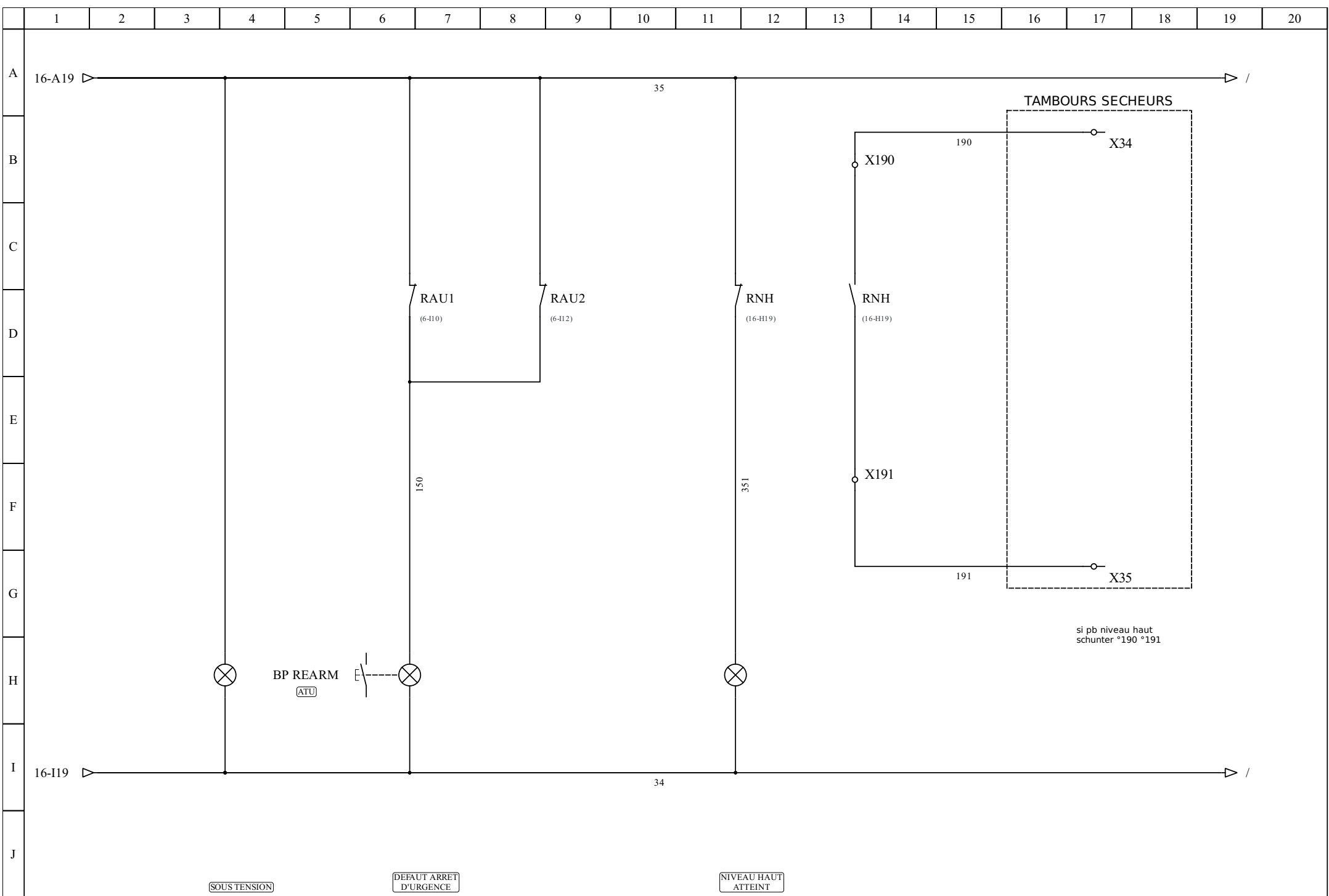

A  
B  
C  
D  
E  
F  
G  
H  
I  
J

# DIGIDRIVE SE 5.5T

PV

GV

PRET

0V      0-10V      +10V      0V      4-20mA      0-10V      100mA      STOP      DEVER      AR      AV      SEL      IMP      100mA

A1      A2      SA      +24V      SL      EL      EL      EL      SEL      EL      +24V

1      2      3      4      5      6      7      8      9      10      11      12      13      14      15      16

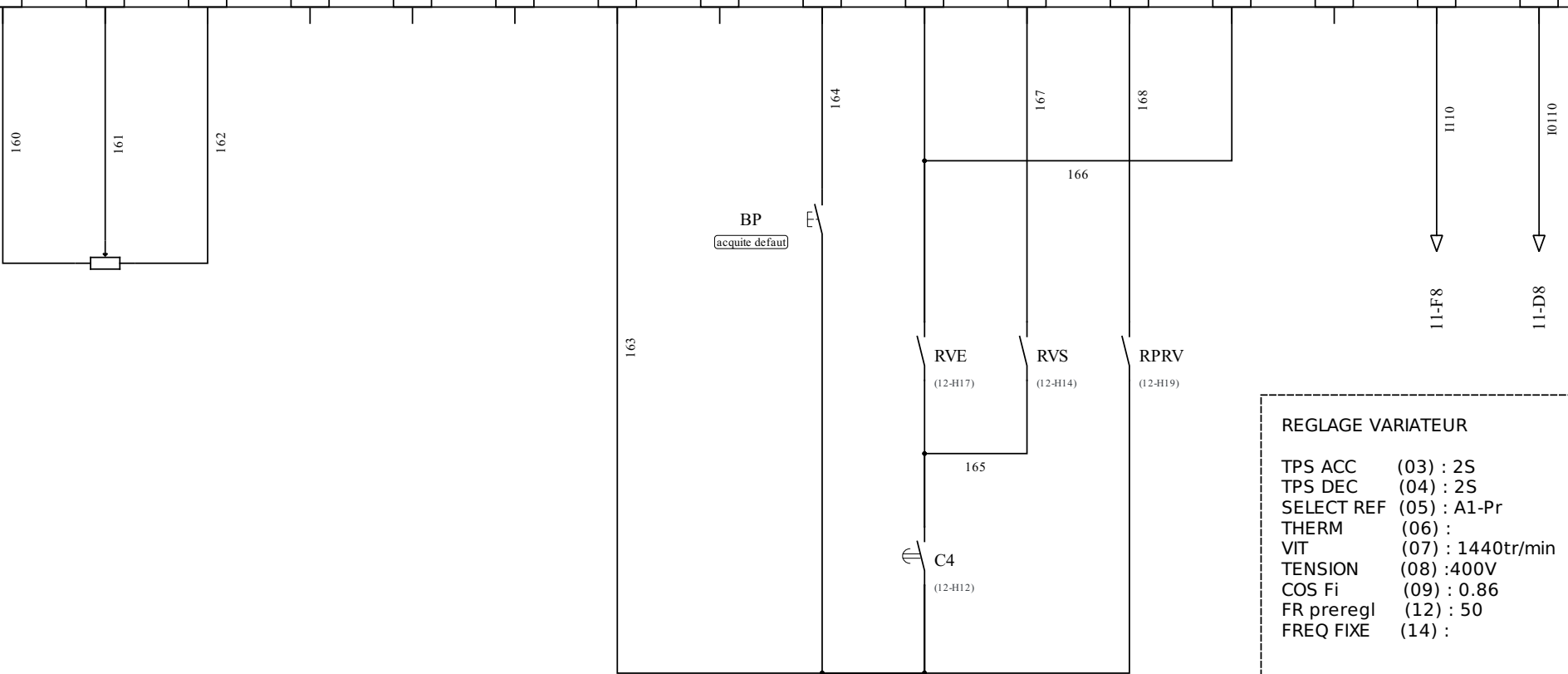

**REGLAGE VARIATEUR**

TPS ACC (03) : 2S  
 TPS DEC (04) : 2S  
 SELECT REF (05) : A1-Pr  
 THERM (06) :  
 VIT (07) : 1440tr/min  
 TENSION (08) : 400V  
 COS Fi (09) : 0.86  
 FR preregl (12) : 50  
 FREQ FIXE (14) :

ACQUITE  
DEFAUT

ORDRE  
MARCHE

BA= 100% CHARGE DONC POUR BLOQUER  
LA CHARGE MAX VERS ~60% = 4.5A

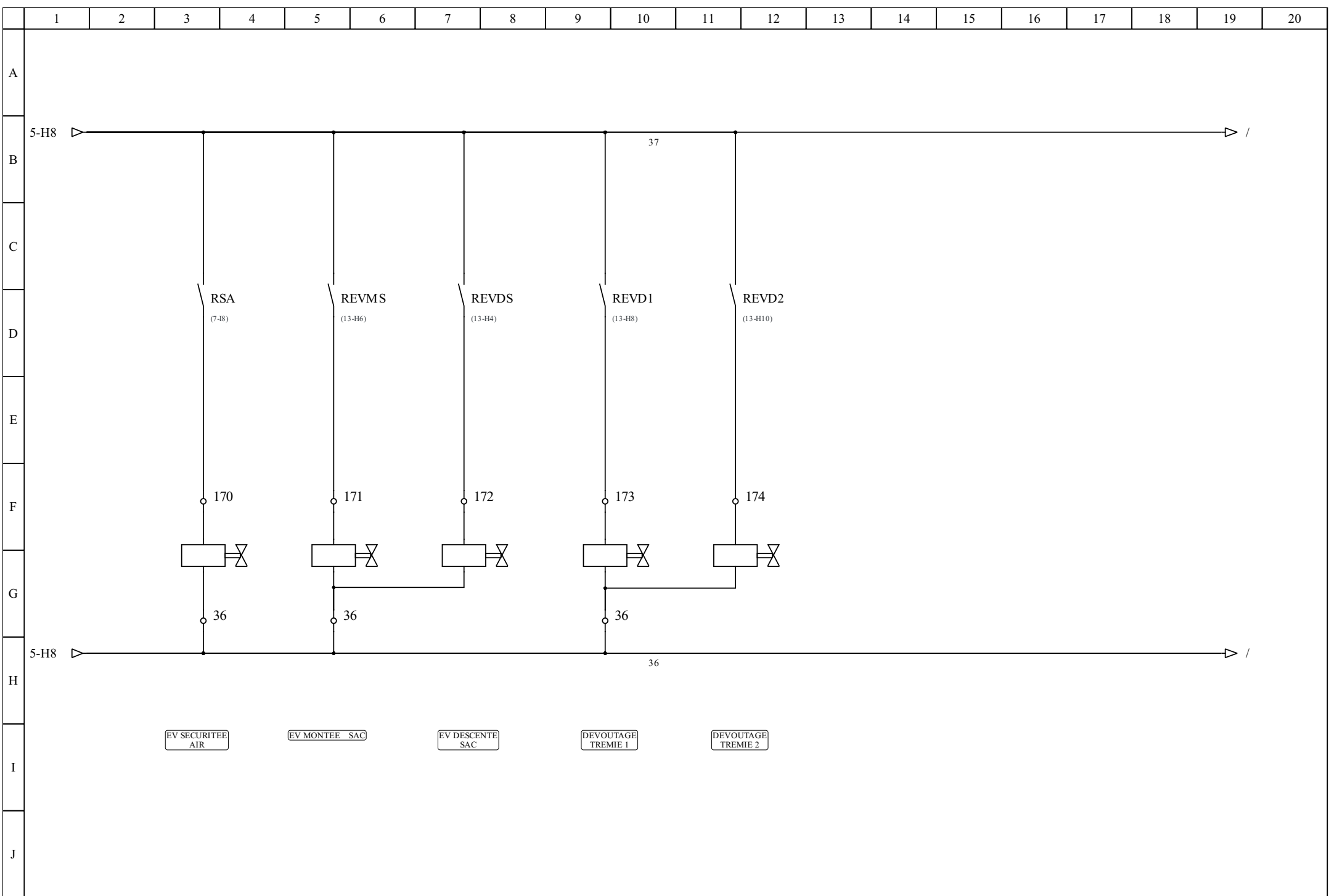

BRANCHÉ SUR PRISE PC1

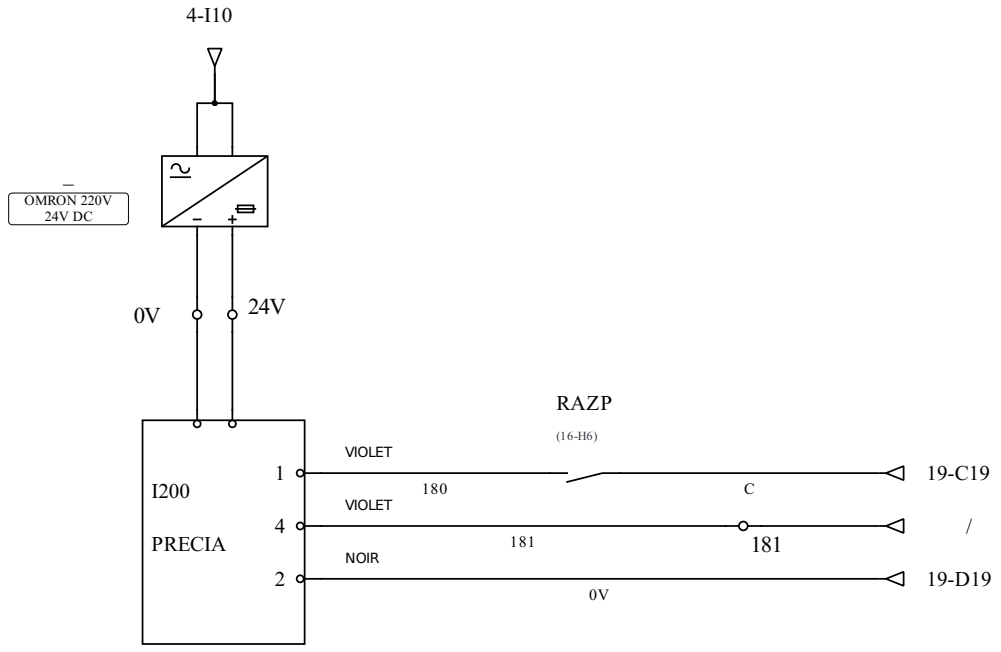

ENTREES I200 PRECIA RAZ DE LA TARE

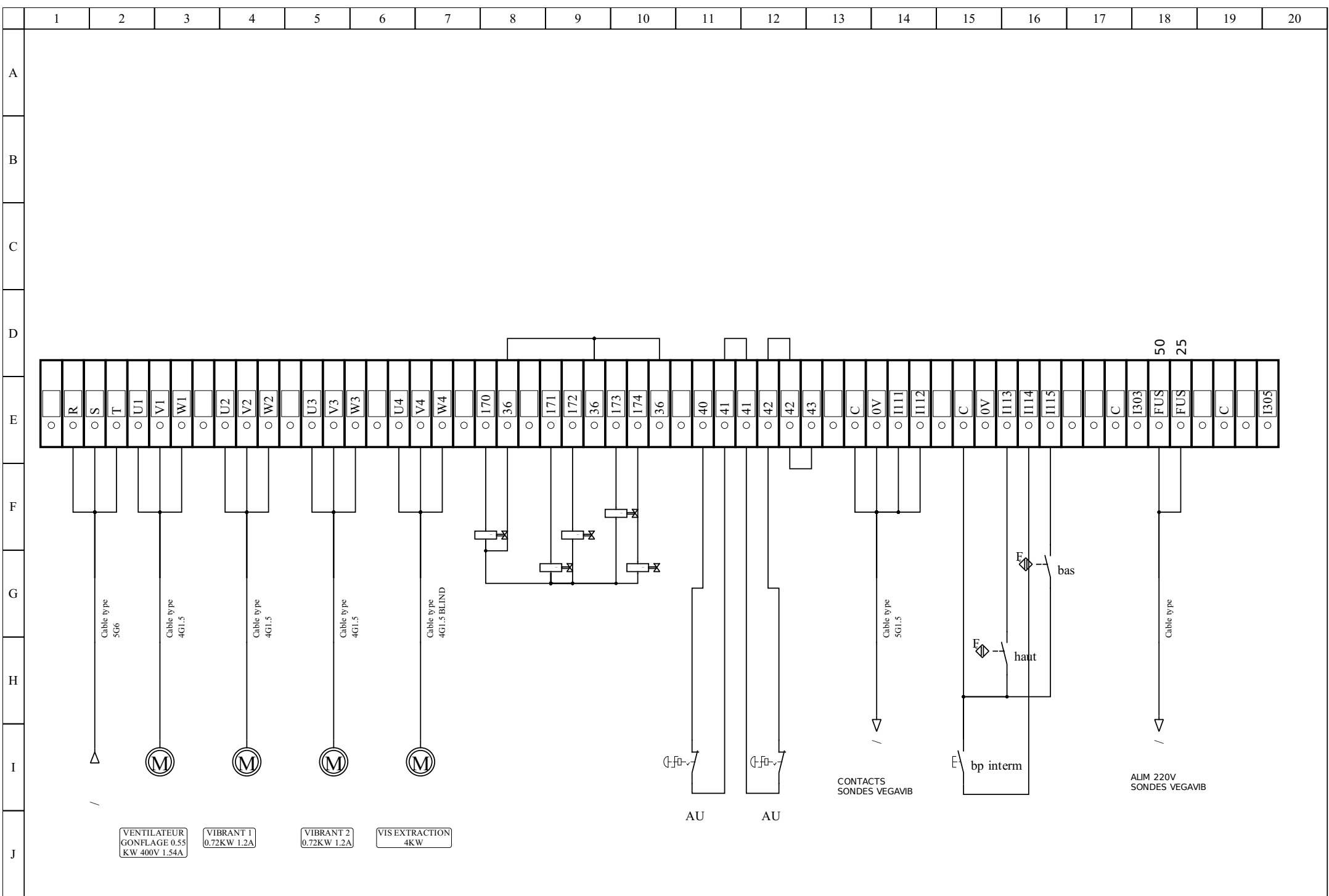

Auteur : LT  
 Date : 18/07/2015

BORNIERS

Fichier : Ensacheuse  
 Folio : 24/28



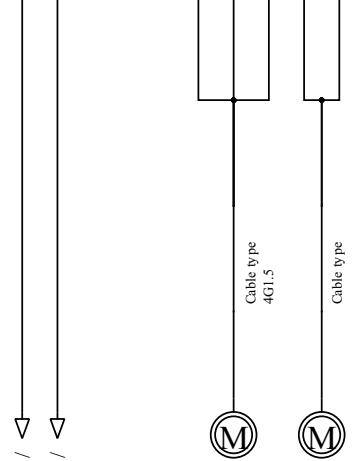
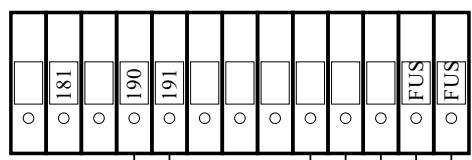

VERS ARMOIRE  
TAMBOURS SECHEURS

VIS TOY  
VENTILATEUR  
PROMAC

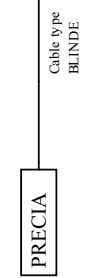
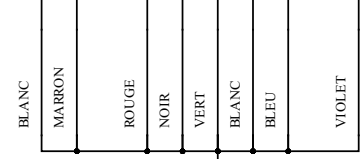
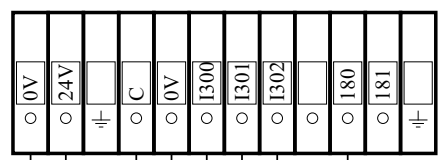

BASCULE

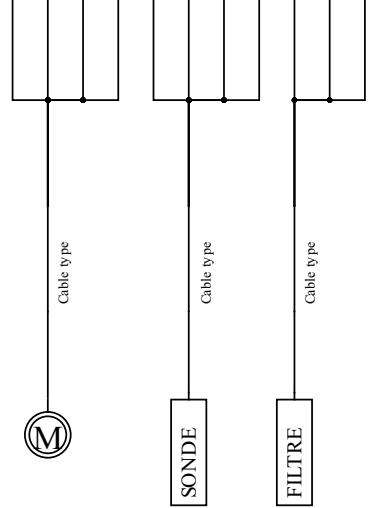
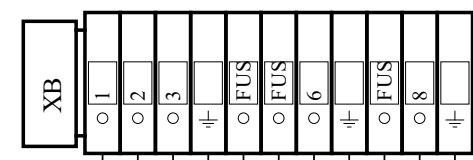

VIS CHAPEAU  
BENNES

SONDE VEGA

DECOLMATAGE  
FILTRE DECOMPRESSION

C 0V S 58 59

	1	2	3	4	5	6	7	8	9	10	11	12	13	14	15	16	17	18	19	20
A	<h1>FOLIO RESERVE</h1>																			
B																				
C																				
D																				
E																				
F																				
G																				
H																				
I																				
J																				

A  
B  
C  
D  
E  
F  
G  
H  
I  
J

DEPUIS ARMOIRE TAMBOURS SECHEURS

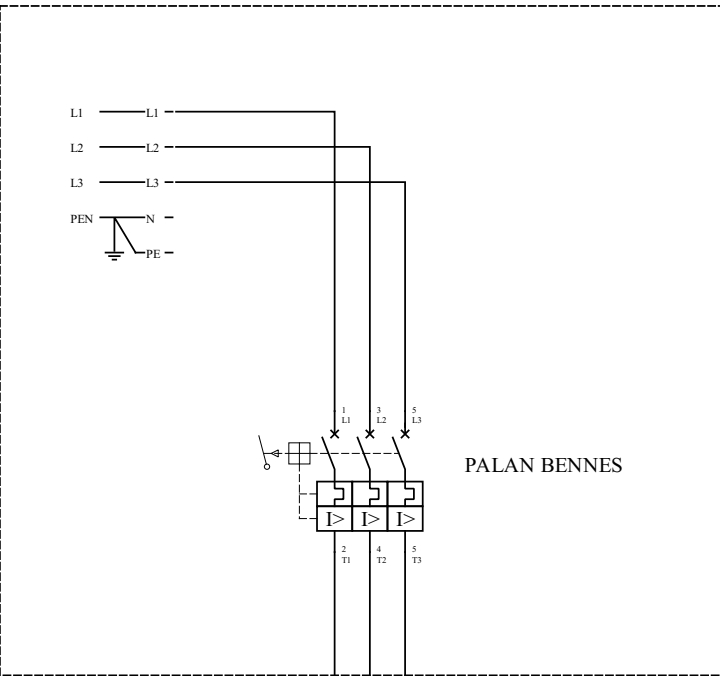

PALAN BENNES

PALAN BENNES

